

CALIPER

- **METROLOGY**® calipers come in brand new designs. Each model is uniquely made with new quality in innovations, function and precision. They are the ultimate market value you will find. We are confident that our products will fully satisfy your demand and earn your trust.
- Each of our brand new designed calipers is developed in Taiwan. Innovated design combines with the workmanship of Swiss. 100% quality control assurance is carried out in our calibration laboratory in Taiwan.
- Metrology calipers are made with hardened stainless steel hardness HRC 48-52. All parts are precision grinded and polished to ensure the requirements for absolute straightness, flatness, parallels, and rigidity.
- Each caliper is calibrated based on the measuring accuracy standards of ISO 3611, DIN 862 in Germany, JIS B7507 in Japan and JCC (Jingstone Calibration Center) in Taiwan. English calibration report is included with every caliper.

DIN 862 CALIPER ACCURACY STANDARDS

Measuring length(mm)	Scale minimum reading values		
	Vernier and Dial		Digital
	0.1 and 0.05mm	0.02mm	0.01mm
50	50	20	20
100			
200			
300			
400	60	30	30
500	70		
600	80		
700	90		
800	100	40	40
900	110		
1000	120		
1200	140		
1400	160	50	
1600	180		
1800	200	60	---
2000	220		

*MPE : Max Permissible Errors UNIT:um(0.001mm)

JIS B7507 CALIPER ACCURACY STANDARDS

Measuring length(mm)	Scale minimum reading values	
	0.1 and 0.05mm	0.02 and 0.01mm
50	±0.05	±0.02
> 50 to 100	±0.06	±0.03
> 100 to 200	±0.07	
> 200 to 300	±0.08	±0.04
> 300 to 400	±0.09	
> 400 to 500	±0.10	±0.05
> 500 to 600	±0.11	
> 600 to 700	±0.12	±0.06
> 700 to 800	±0.13	
> 800 to 900	±0.14	±0.07
> 900 to 1000	±0.15	

*Permissible errors of calipers UNIT : mm



Vernier



Dial

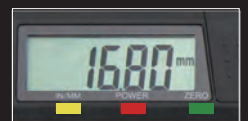

Digital

- The all new designed calipers come in Vernier, dial, and digital displays. Models with measuring range within 300mm are equipped with external, internal, depth and step measuring utilities. Other special models come with special utilities.



VERNIER CALIPER

Best Vcal

METROLOGY®



Precision. unique. innovation.

Best Vcal

VERNIER CALIPER

PRECISION UNIQUE INNOVATION

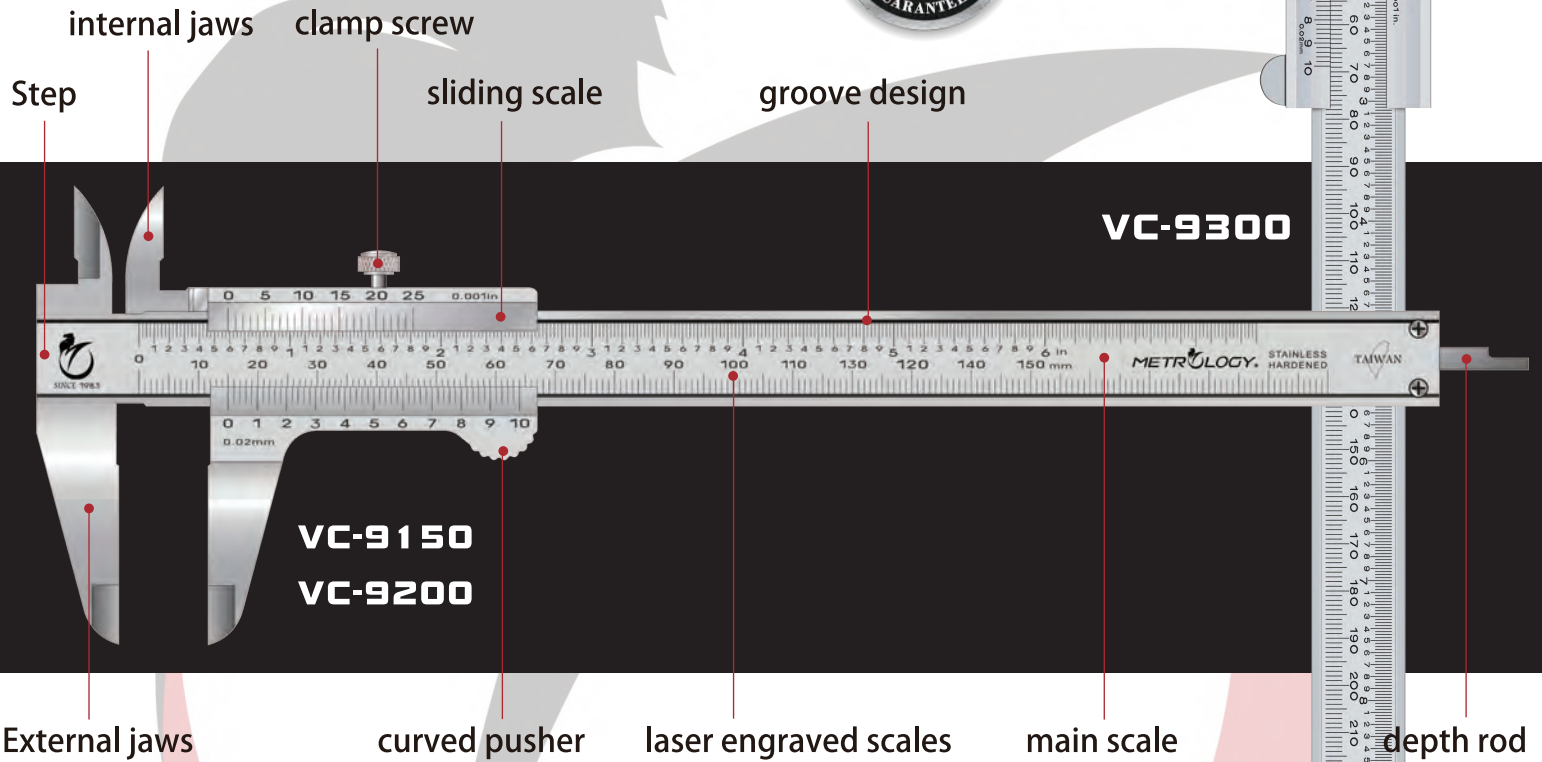

FEATURE

- 4 measuring utilities: external, internal, depth, and steps.
- Hardened stainless steel hardness HRC48-52 and close type sliding scale structure design.
- Solid structural design with precision machining, chrome plating surface, laser engraved scale, guarantee wear resistance.
- Ergonomic design curved pusher, external and internal jaws for easy to use and safety.
- Unique, innovative groove-design of main scale, for eliminating dust and grease, reduce sliding friction resistance.

Model No.	Measuring Range	Graduation	Accuracy (MPE)
VC-9150	0-150mm/6"		0.02mm/0.0010"
VC-9200	0-200mm/8"	0.02mm/0.001"	0.03mm/0.0010"
VC-9300	0-300mm/12"		0.04mm/0.0015"

Remark : VC-9300 Without groove design MPE : Max Permissible Errors

METROLOGY[®]

Expert of Measuring Instrument

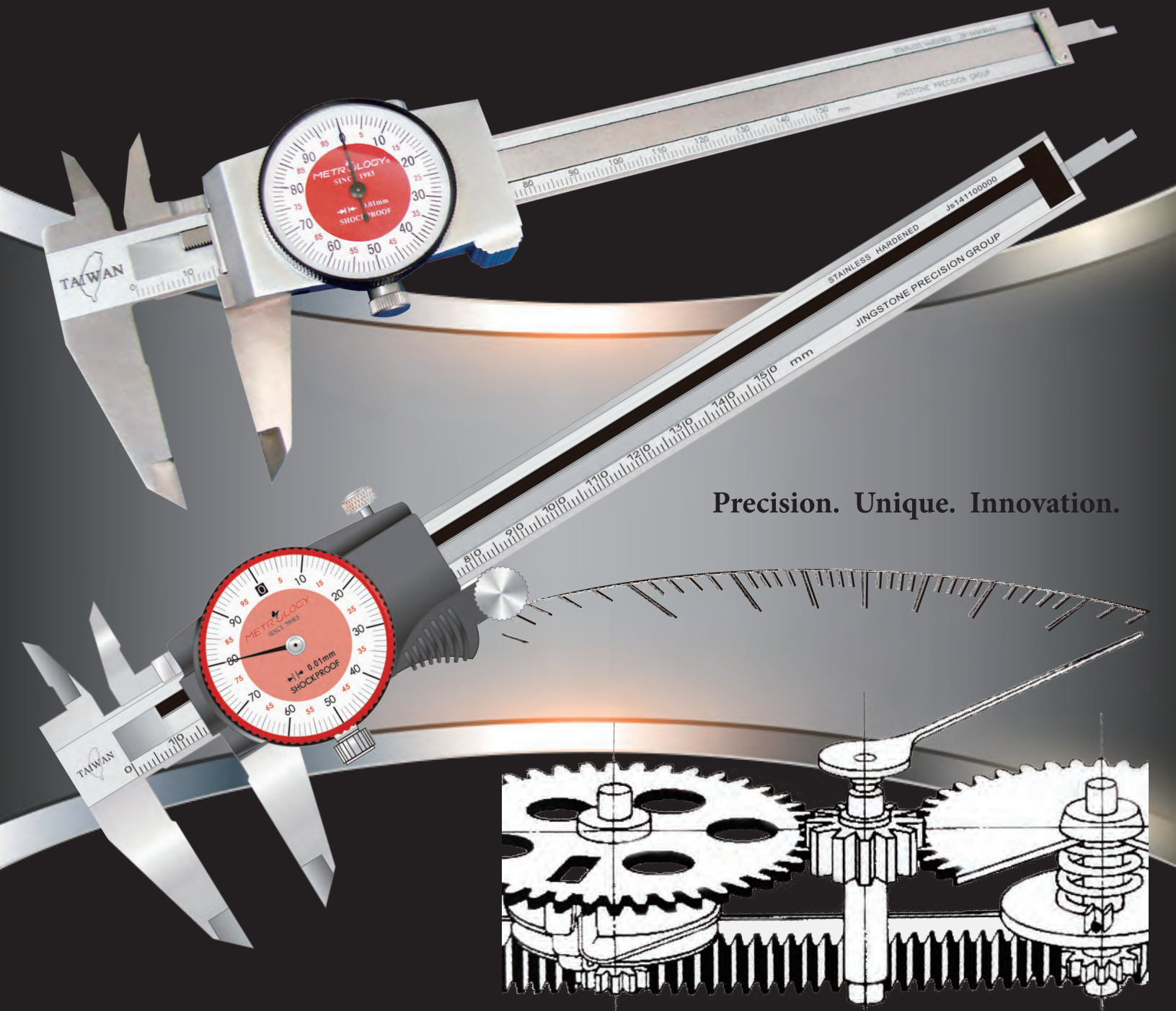

Precision. Unique. Innovation.

TAIWAN DESIGN

SWISS MODULE

D-SHOCKPROOF

DIAL CALIPER

Swiss Style Dial Caliper

SHOCKPROOF

- ★ Metrology Swiss Style Dial Caliper utilized Swiss style gear module sets and double shockproof design. Made from hardened stainless steel hardness HRC48-52. It is a highly precise, highly accurate measuring tool.
- ★ All new uniquely design dial bezel and scale, pointer revolution 1mm graduation with sharp and easy readings. Greatly reduced eye-fatigue and vision errors.
- ★ Laser engraved scale, ensuring easy reading, its durability, and wear-tear resistance. The sliding scale makes use of enclosed structural design, low backlash, making sure smooth slides and warp-resistance.
- ★ Metrology Swiss Style Calipers are perfect for any workshops or quality control facilities. Each caliper comes with factory warranty and certificates according to German DIN 862, and Jingstone Calibration Center(JCC) standard in Taiwan.

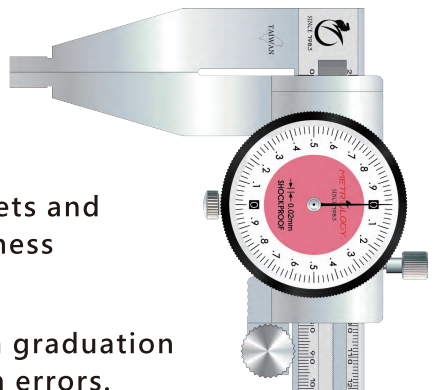

DC-9001H
Chrome plating metal casing

1 revolution 1mm

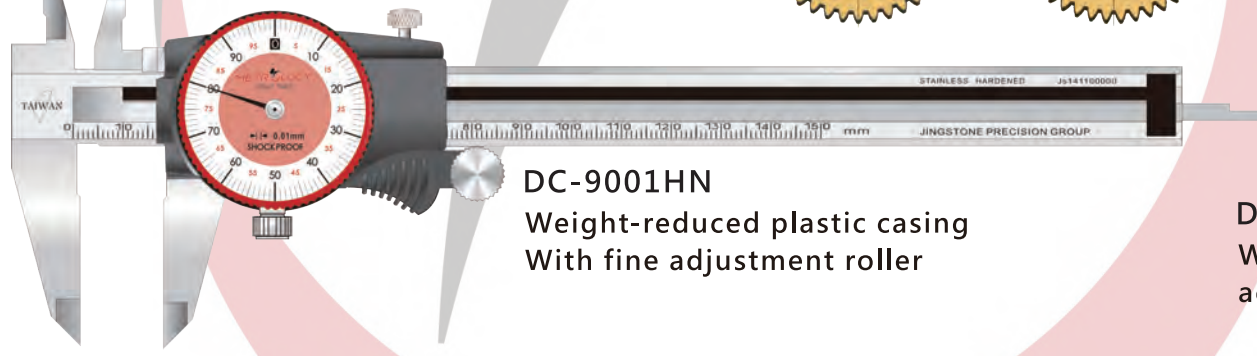
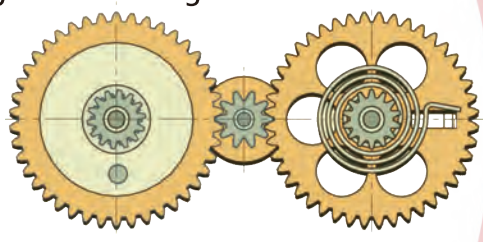

DC-9001HN
Weight-reduced plastic casing
With fine adjustment roller

DC-9500
With fine adjustment roller



Model No.	Measuring Range	Graduation	Accuracy (MPE)	Remark
DC-9001H	0-150mm		0.02mm	
DC-9002H	0-200mm	0.01mm	0.03mm	Chrome-plated metal housing
DC-9003H	0-300mm		0.04mm	
DC-9001HT	0-150mm		0.02mm	Chrome-plated metal housing.
DC-9002HT	0-200mm	0.01mm	0.03mm	Tungsten Steel Measuring Jaw
DC-9003HT	0-300mm		0.04mm	(inner & ext.)
DC-9001HN	0-150mm		0.02mm	Light-weight plastic housing.
DC-9002HN	0-200mm	0.01mm	0.03mm	With fine -adjustment roller.
DC-9003HN	0-300mm		0.04mm	
DC-9500	0-500mm	0.02mm	0.05mm	With fine -adjustment roller.

METROLOGY®

DIGITAL CALIPERS



Precision. unique. innovation.

Digital Caliper

Pretty SERIES Optical Glass Measuring System IP54

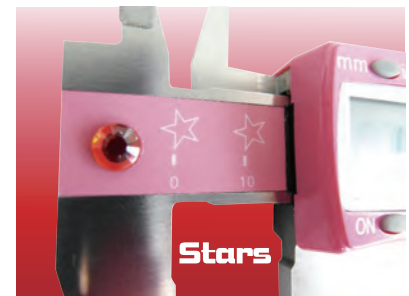
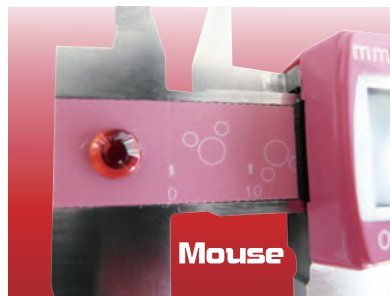
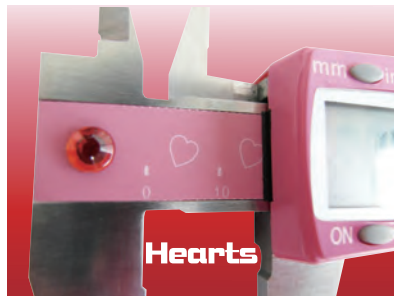

- ◆ Metrology Pretty Pink Caliper! Special design with a feminine touch, intended to cheer up any work space. Limited production/ great for collection or gifts.
- ◆ Metrology Pretty series digital caliper features the latest rapid-induction scan chip for value-reading system. Automatically memorize measurement value at any time and any position, whether it's power on or power off. The display functions normally regardless fast sliding. Durable, stable, longer operation life.
- ◆ Composite Optical Glass Capacitive Sensing Raster Measuring System which is a step-up from the traditional brass raster measuring scale. New system prevents magnetic interference. Variation of temperature does not influence the measuring accuracy, also the display unit function normally in humid conditions.
- ◆ High quality enclosed sliding structure, main scale is integrated, made of hardened stainless steel, hardness HRC 48-52. Precision lapping measuring face, accuracy is according to Germany DIN, Japan JIS, International ISO, and JCC Taiwan.
- ◆ European styling ergonomic design curved pusher and thumb roller to ensure the stability and comfort.
- ◆ CR2032 3V lithium battery/energy efficient/ battery life 1 year or over.
- ◆ 10 mm super large display/ Sharp display and easy to read, reduce eye fatigue and vision error.
- ◆ Bottom functions MM/IN : Metric and Imperial conversion ABS : absolute and increment value
ZERO : setting zero at any position ON/OFF : manual on / off switch and auto power



Pink main scale and pink plastic case

Model No.	Type	Measuring Range	Resolution	Accuracy (MPE)
EC-9001PH	Heart	0-150mm/6"	0.01mm/0.0005"	0.03mm/0.0015"
EC-9001PM	Mouse			
EC-9001PS	Star			

Precision Unique Innovation



TAIWAN PATENT

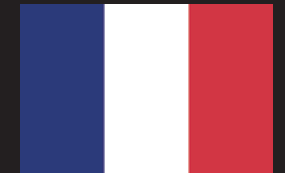

CALIPER

Registered / Eingetragen 06/08/2007

EU INTERNATIONAL PATENT

No 000769922-0001

Lee Ching Tzong
Jingstone Precision Measurement & Calibration Technology
International Consultant Co., Ltd.

- BG - Bilyákpé 保加利亞
- ES - Calibres 西班牙
- CS - Průměřky 捷克
- DA - Passere 丹麥
- DE - Gabellehren 德國
- ET - Nihakud 愛沙尼亞
- EL - Πασσιέρες 希臘
- EN - Calipers 英國
- FR - Calibres 法國
- IT - Calibri 義大利
- LV - Ārtausti 拉脫維亞
- LT - Skersluvi 立陶宛
- HU - Mértőközők tolmérmécek 匈牙利
- MT - Kalipers 馬其頓
- NL - Fijthaken 荷蘭
- PL - Suwmiarki 波蘭
- PT - Calibres 葡萄牙
- RO - Şubiere 俄羅斯
- SK - Posuvné meradlá 斯洛伐克
- SL - Šestila 斯洛維尼亞
- FI - Mittaharit 芬蘭
- SV - Passare 瑞典

The President / Der Präsident

Wubbo de Boer



OHIM – OFFICE FOR HARMONIZATION
IN THE INTERNAL MARKET
TRADE MARKS AND DESIGNS

CERTIFICATE OF REGISTRATION

This Certificate of Registration is hereby issued for the Registered Community Design identified below. The corresponding entries have been recorded in the Register of Community Designs.

HABM – HARMONISIERUNGSAMT FÜR
DEN BINNENMARKT
MARKEN, MUSTER UND MODELLE

EINTRAGUNGSURKUNDE

Diese Eintragungsurkunde wird für das unten genannte Gemeinschaftsgeschmacksmuster ausgestellt. Die entsprechenden Einträge sind in das Register für Gemeinschaftsgeschmacksmuster aufgenommen worden.

Digital Caliper Optical Glass Measuring System **IP54** **FRACTION SERIES**

- ★ Metrology Fraction Series digital caliper features the latest rapid-induction scan chip for value-reading system. Automatically memorize measurement value at any time and any position.
- ★ Composite Optical Glass Capacitive Sensing Raster Measuring System which is a step-up from the traditional brass raster measuring scale. New system prevents magnetic interference. Variation of temperature does not influent the measuring accuracy, also the display unit function normally in humid conditions.

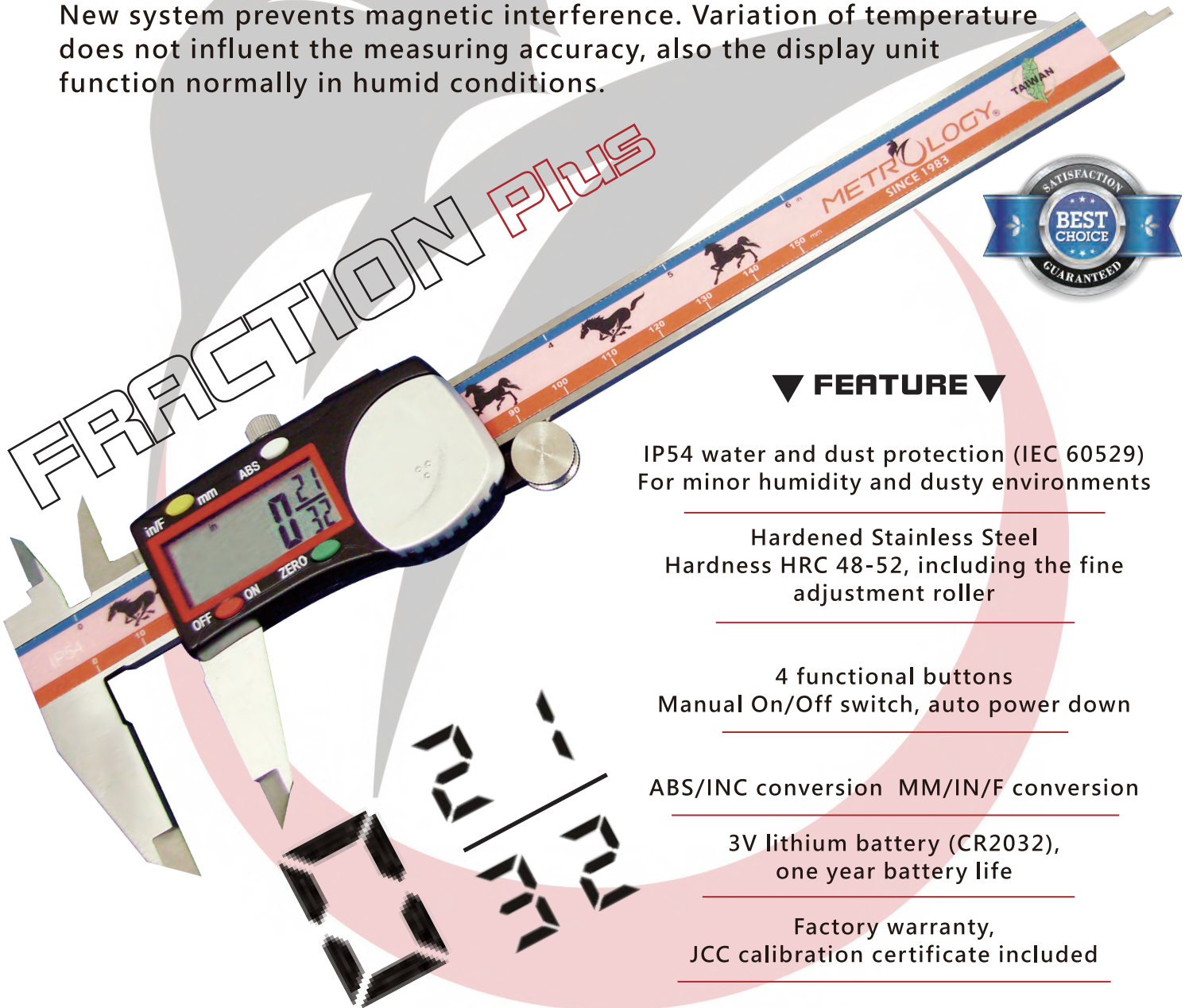

▼ FEATURE ▼

IP54 water and dust protection (IEC 60529)
For minor humidity and dusty environments

Hardened Stainless Steel
Hardness HRC 48-52, including the fine
adjustment roller

4 functional buttons
Manual On/Off switch, auto power down

ABS/INC conversion MM/IN/F conversion

3V lithium battery (CR2032),
one year battery life

Factory warranty,
JCC calibration certificate included

Model No.	Measuring Range	Resolution	Accuracy (MPE)
EC-9001WF	0-150mm/6"	0.01mm/0.0005"	0.03mm/0.001"
EC-9002WF	0-200mm/8"		0.03mm/0.0015"
EC-9003WF	0-300mm/12"		0.04mm/0.0015"

Digital Caliper

MICRO SERIES Optical Glass Measuring System IP54

- Metrology Micron Series digital caliper features the latest rapid-induction scan chip for value-reading system. Automatically memorize measurement value at any time and any position.
- Composite Optical Glass Capacitive Sensing Raster Measuring System which is a step-up from the traditional brass raster measuring scale. New system prevents magnetic interference. Variation of temperature does not influence the measuring accuracy, also the display unit function normally in humid conditions.
- 10 mm super large LCD display/ 0.005mm high resolution, measuring accuracy according to DIN/JIS/ISO and JCC standards.



▼ FEATURE ▼

IP54 water and dust protection (IEC 60529)
For minor humidity and dusty environments

Hardened Stainless Steel
Hardness HRC 48-52, including fine
adjustment roller

4 functional buttons
Manual On/Off switch, auto power down

ABS/INC conversion
MM/IN conversion, Zero, On/Off button

1.5V lithium battery (LR44),
one year battery life

Factory warranty,
JCC calibration certificate included

MICRO

0.005mm

Model No.	Measuring Range	Resolution	Accuracy (MPE)
EC-9001WH	0-150mm/6"	0.005mm/0.0005"	0.020mm/0.001"
EC-9002WH	0-200mm/8"		0.025mm/0.0015"
EC-9003WH	0-300mm/12"		0.030mm/0.0015"

Digital Caliper Optical Glass Measuring System **IP54**

ABSOLUTE SERIES

- ✓ Metrology Absolute Series digital caliper features absolute sensor measuring system, for fast and reliable measurement, no need to repeatedly reset zeros, even after power down or replacing battery, the original data stays the same, also no induction speed limit.
- ✓ SPC port allows data import through USB. No software required. Data can be transfer directly to Excel.

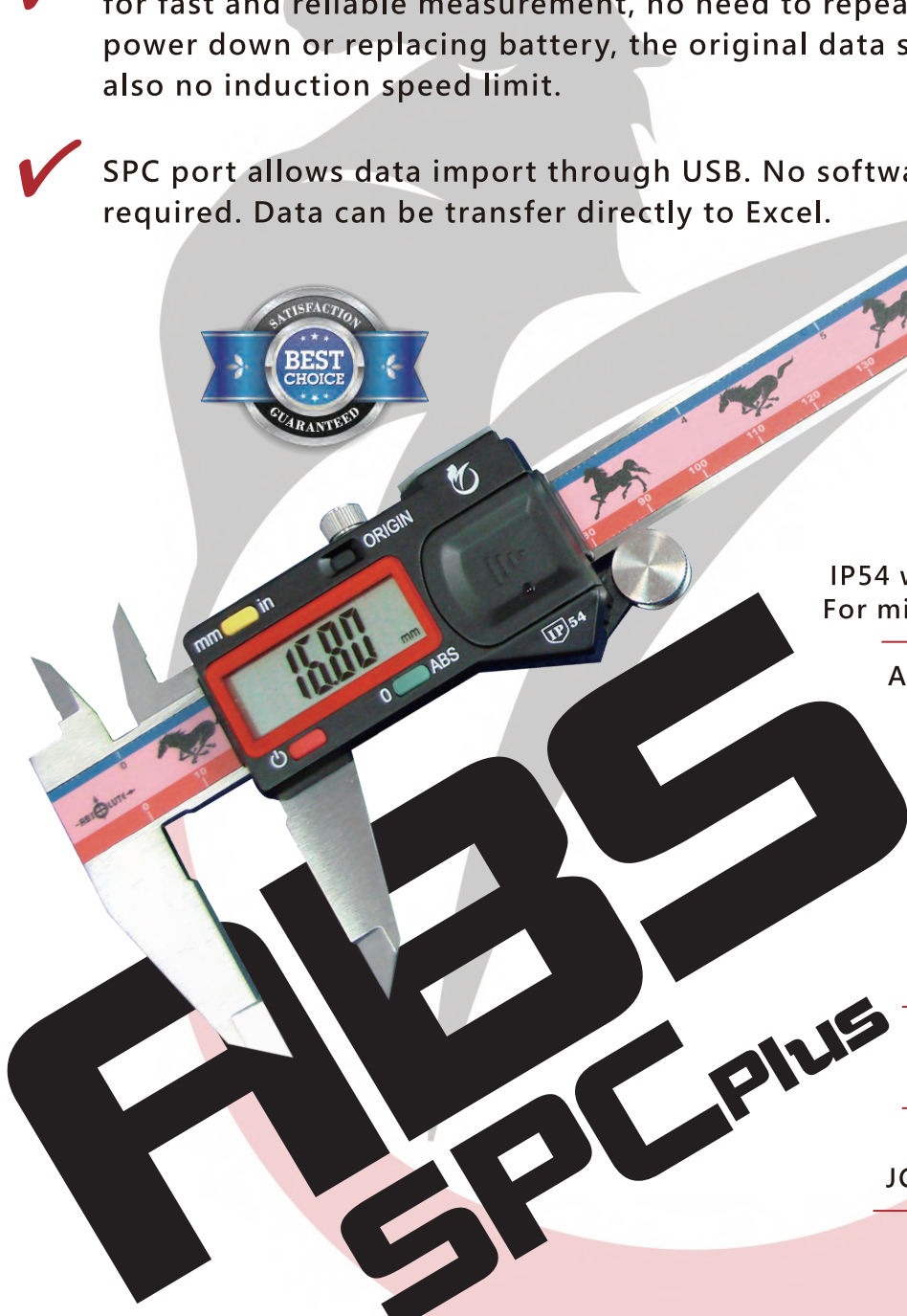

▼ FEATURE ▼

IP54 water and dust protection (IEC 60529)
For minor humidity and dusty environments

Absolute sensor measuring system
Limitless induction speed

Hardened Stainless Steel
Hardness HRC 48-52, including fine adjustment roller

4 functional buttons
ABS/ZERO & MM/IN conversion
ORIGIN & Power ON/OFF

3V lithium battery (CR2032),
one year battery life

Factory certified,
JCC calibration certificate included



Model No.	Measuring Range	Resolution	Accuracy (MPE)
EC-9001AB	0-150mm/6"	0.01mm/0.0005"	0.03mm/0.001"
EC-9002AB	0-200mm/8"		0.03mm/0.0015"
EC-9003AB	0-300mm/12"		0.04mm/0.0015"

Optional accessories: Data output cable (DO-B+C04) · Bluetooth data transmitter (DO-W2-RS)

line chart

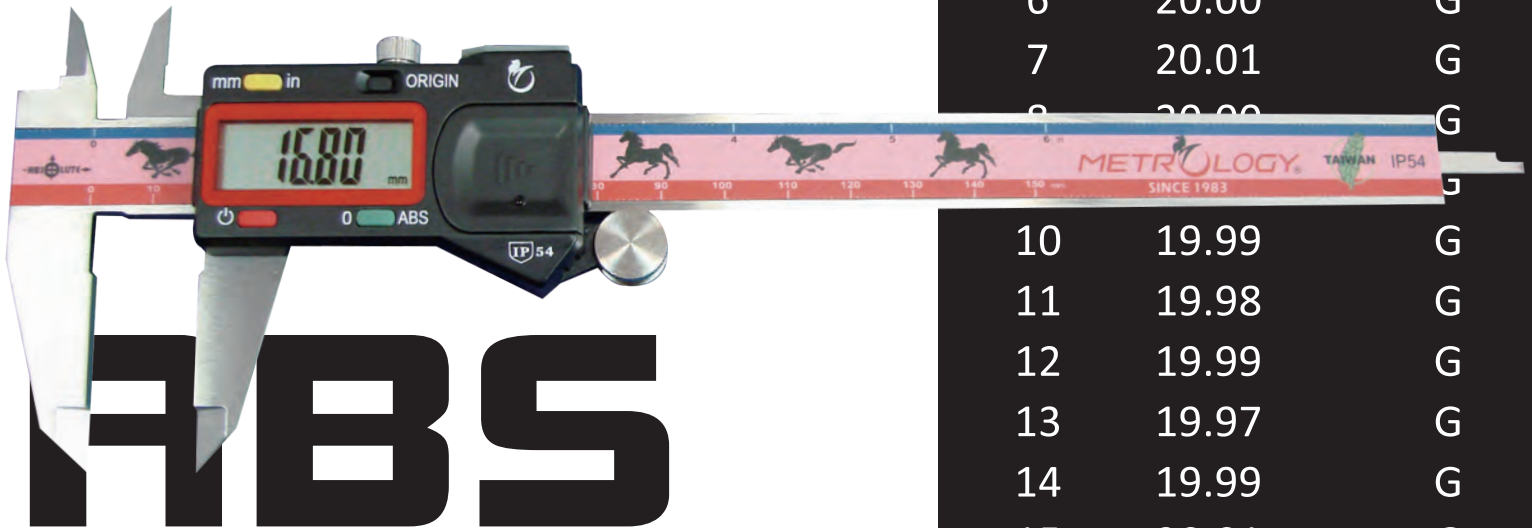
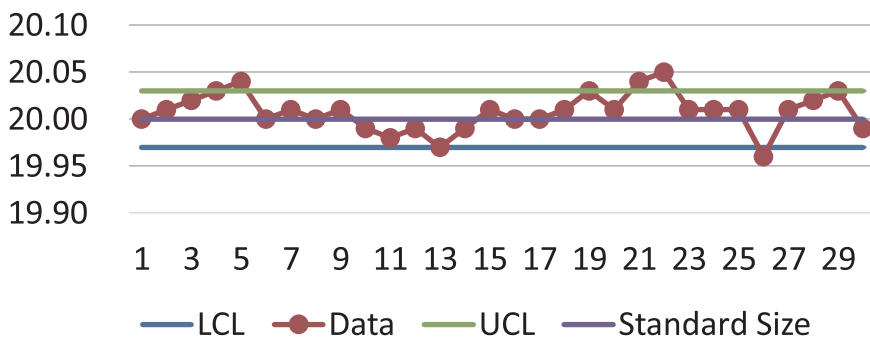

Run Chart

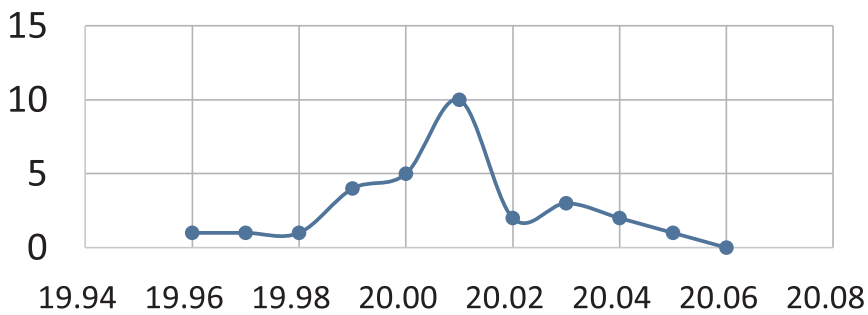

Histogram

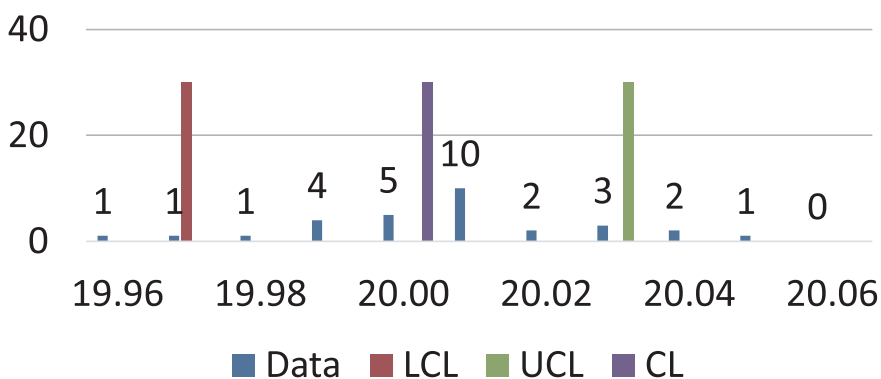

Number	Value	Conclusion
1	20.00	G
2	20.01	G
3	20.02	G
4	20.03	G
5	20.04	+
6	20.00	G
7	20.01	G
8	20.00	G
9	20.00	G
10	19.99	G
11	19.98	G
12	19.99	G
13	19.97	G
14	19.99	G
15	20.01	G
16	20.00	G
17	20.00	G
18	20.01	G
19	20.03	G
20	20.01	G
21	20.04	+
22	20.05	+
23	20.01	G
24	20.01	G
25	20.01	G
26	19.96	-
27	20.01	G
28	20.02	G
29	20.03	G
30	19.99	G

SUBMARINE

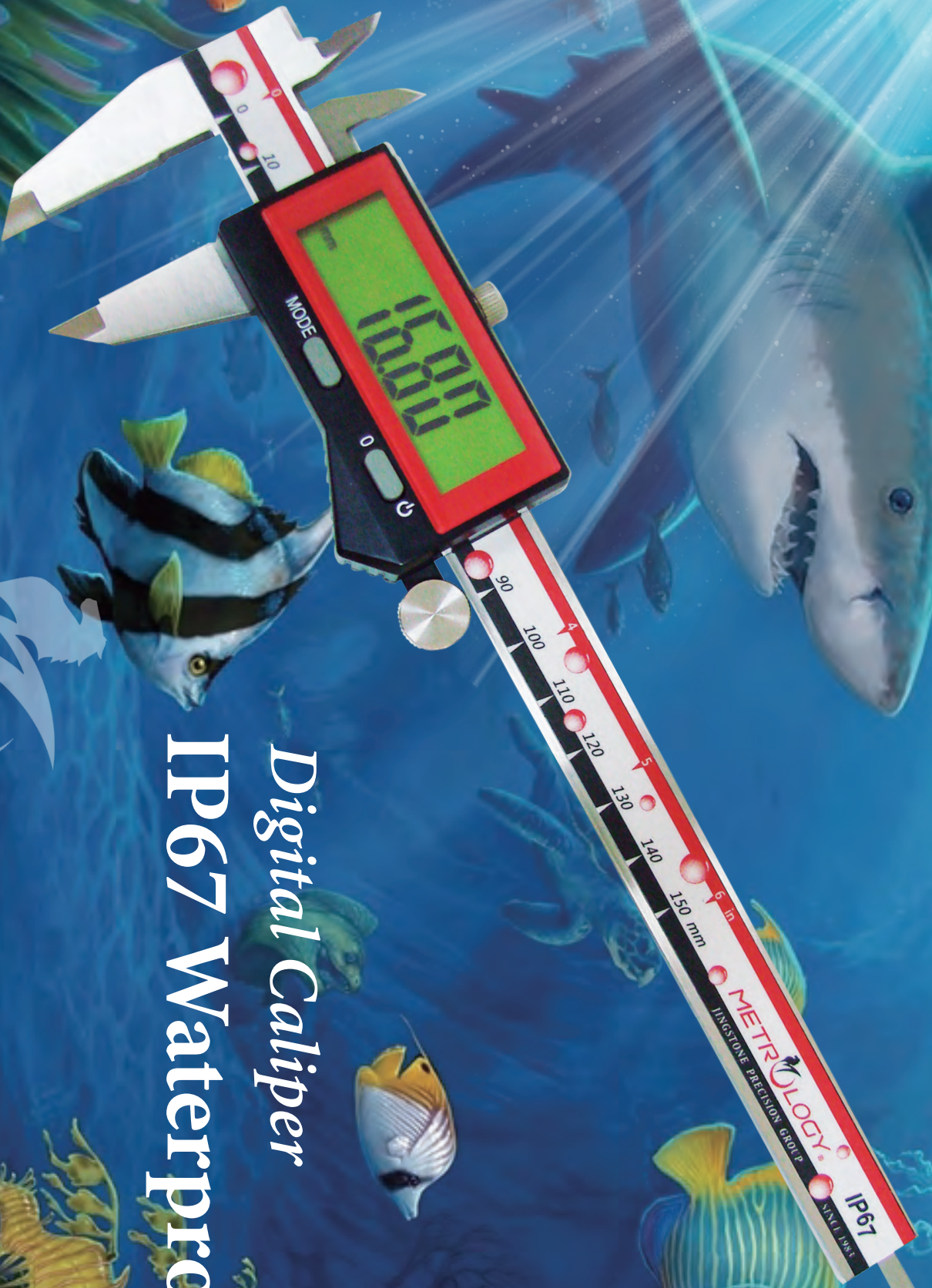

Digital Caliper
IP67 Waterproof

METROLOGY®

- ▶ Metrology IP67 Series digital caliper features the latest rapid-induction scan chip for value-reading system. Automatically memorize measurement value at any time and any position. **IP67**
- ▶ IP 67 water/dust proof (IEC 60529), complete waterproof, greaseproof/operational in water, high stability and longer life.
- ▶ Features two buttons measuring system, for easy & fast and reliable measurement, no need to repeatedly reset zeros, also no induction speed limit.
- ▶ Optional SB type calipers with builtin bluetooth wireless transmission, no need to install any software to send data to computers and mobile phones for editing and calculation of E-documents or Excel.

Digital Caliper SUBMARINE

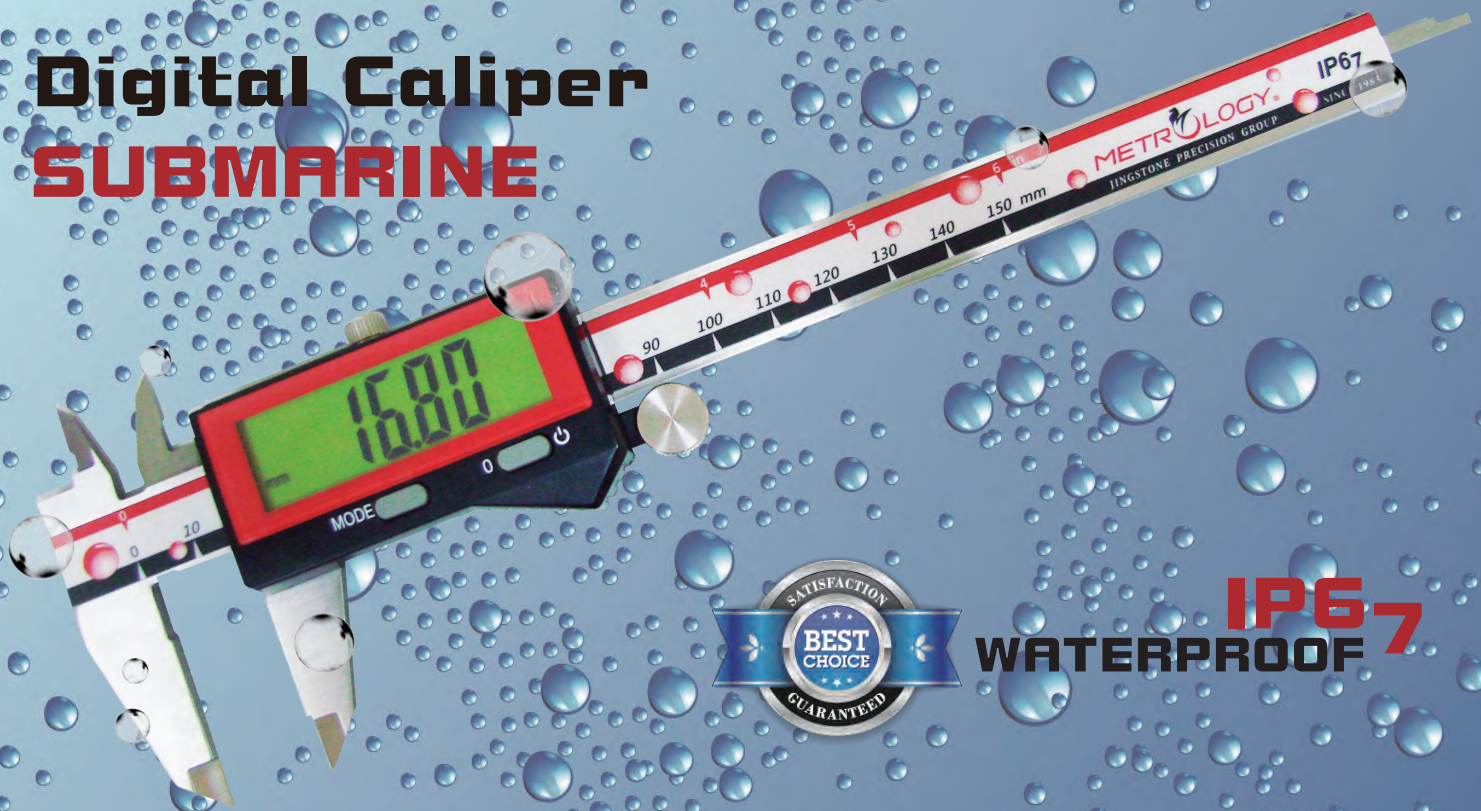

FEATURE

- ▶ IP67 (IEC60529) complete waterproof/greaseproof, under normal water pressure and submerge time
- ▶ 11mm super large LCD display
Limitless induction speed
- ▶ Made of hardened stainless steel hardness HRC48-52 including fine adjust roller
- ▶ Two menu function buttons/
manual On and Off/ auto power down
- ▶ ZERO and MM/IN conversion
- ▶ 3V lithium battery (CR2032), 2000 hr. life time.
- ▶ Factory warranty, JCC calibration certificate included

Model No.	Measuring Range	Resolution	Accuracy (MPE)
EC-9001SS	0-150mm/6"	0.01mm/0.0005"	0.03mm/0.0010"
EC-9002SS	0-200mm/8"		0.03mm/0.0015"
EC-9003SS	0-300mm/12"		0.04mm/0.0015"

*Optional: SB type calipers with builtin bluetooth wireless transmission

CALIPER

- **METROLOGY**® Special Jaws Calipers, unique and modern design, solid structure made of hardened stainless steel hardness HRC 48-52, measuring anvils and jaws are precision grinded and polished.
- This series of calipers are design to suit special requirements/ manufacturing accuracy is based on ISO standards, in compliance to JCC.

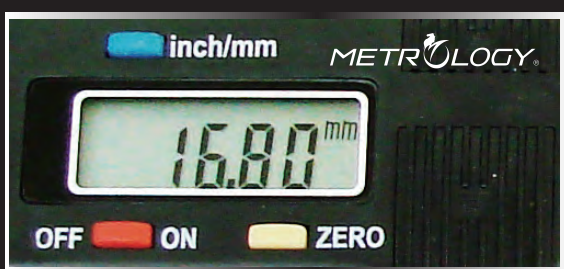

- Resolution: 0.01mm/ 0.0005"
- MM/INCH conversion button
- Manual ON/OFF button
- ZERO: Reset button
- 1.5V, LR 44 lithium battery

SPECIAL MEASURING JAWS

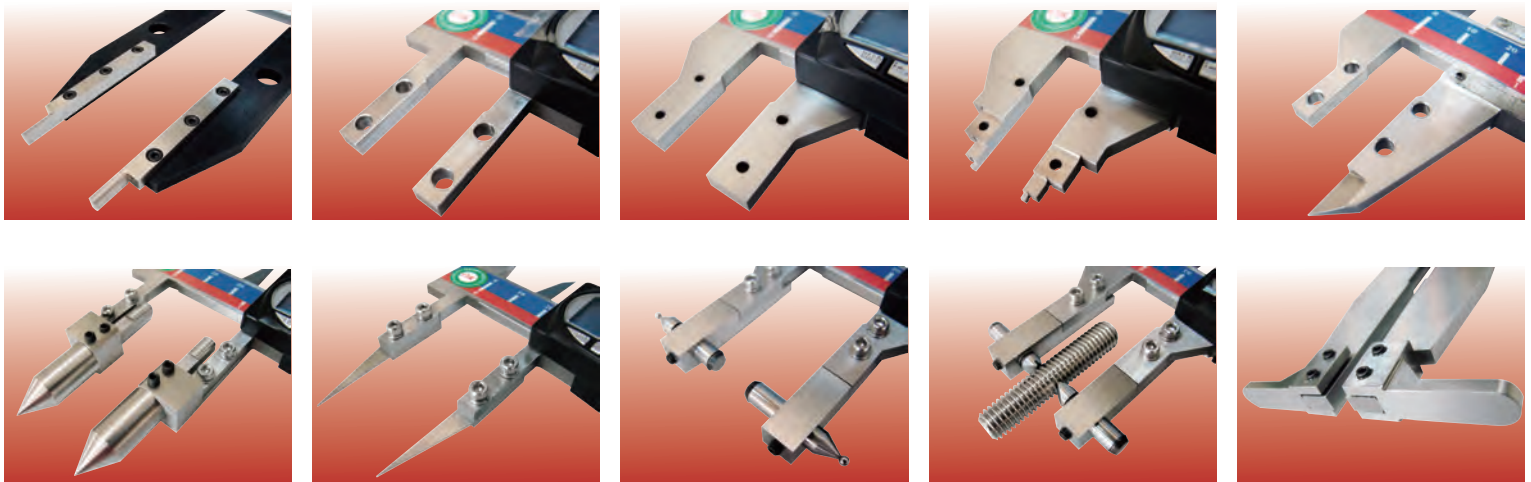
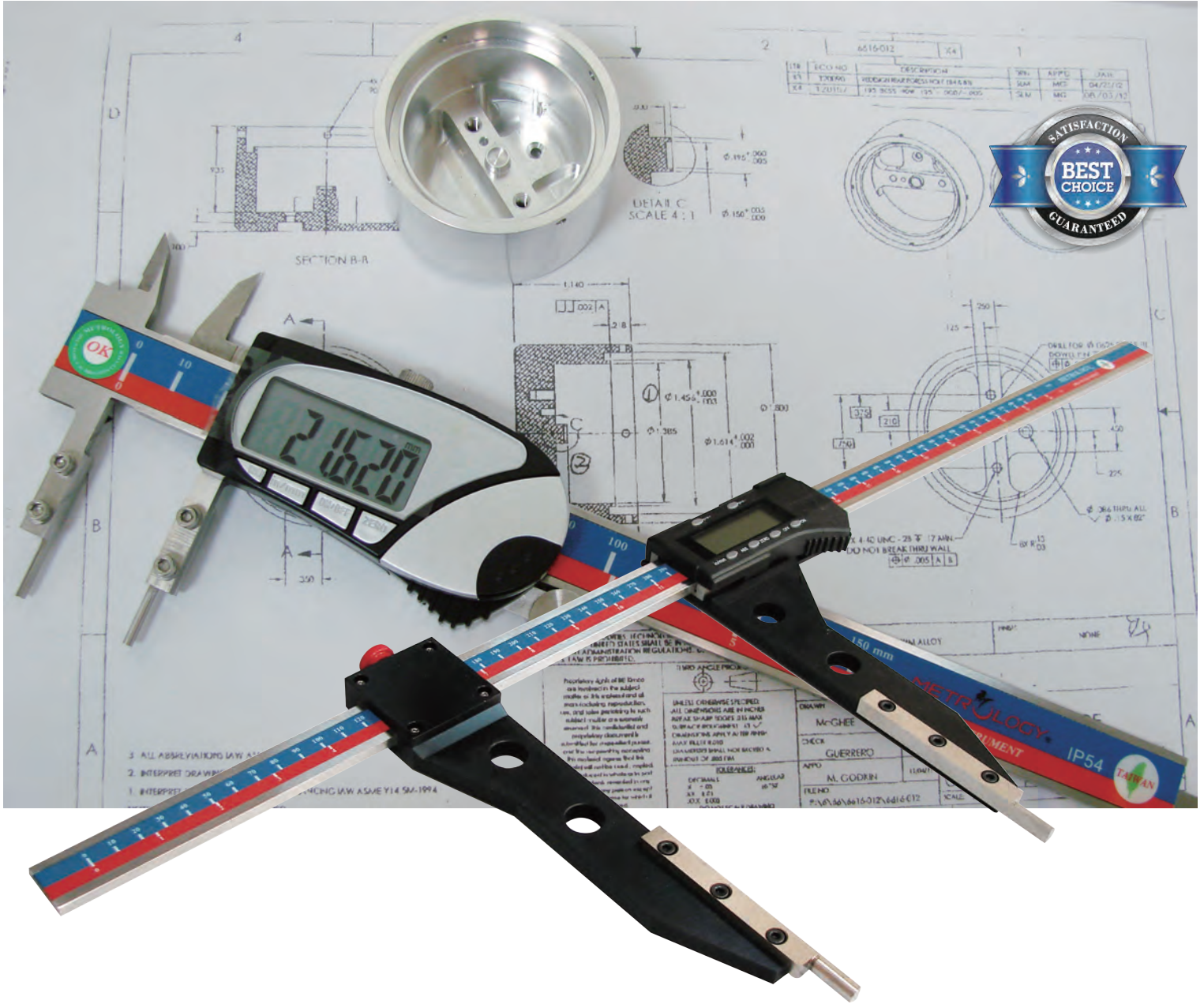

*The measuring jaw can be customized according to design drawing or measurement item of workpiece to suit your particular requirements.

■ Digital Caliper (Tungsten Steel)

For measuring high density materials, measuring the external, internal, depth, and step of work pieces. Tungsten steel on both internal and external jaws, ensuring durability.

Tungsten carbide is much more wear-resistant and durable than hardened stainless steel.

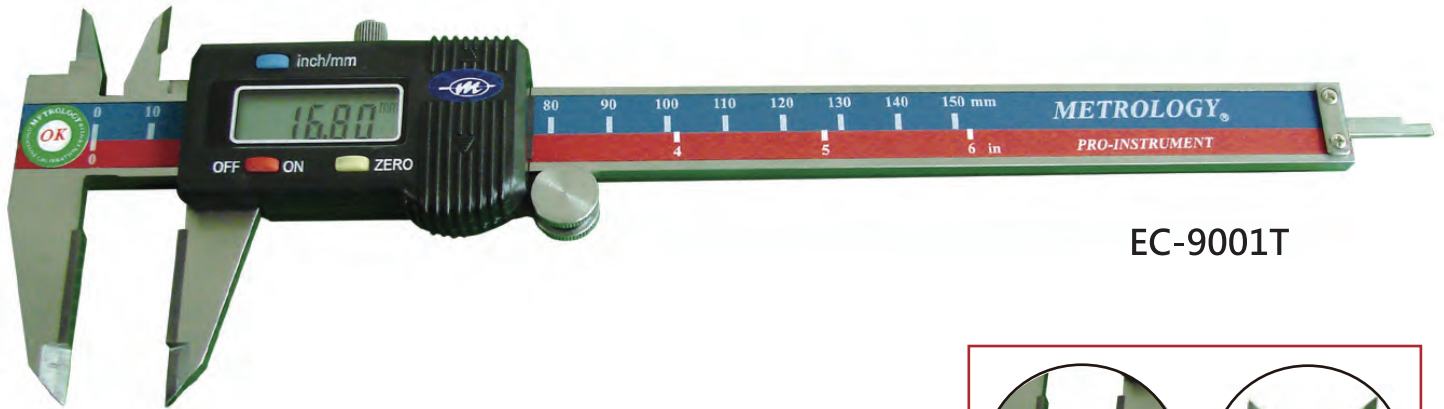

EC-9001T

Model No.	Measuring Range	Resolution	Accuracy
EC-9001T	0-150mm/6"	0.01mm/0.0005"	±0.03mm
EC-9002T	0-200mm/8"		±0.03mm
EC-9003T	0-300mm/12"		±0.04mm

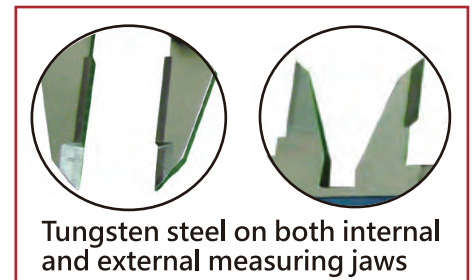

■ Digital Caliper (Depth)

For depth, thickness, height, and step measurements



EC-9001DP

Model No.	Measuring Range	Resolution	Base Length	Accuracy
EC-9001DP	0-150mm/6"	0.01mm/0.0005"	100mm	±0.03mm
EC-9002DP	0-200mm/8"		100mm	±0.03mm
EC-9003DP	0-300mm/12"		150mm	±0.04mm
EC-9004DP	0-500mm/20"		200mm	±0.05mm
EC-9005DP	0-800mm/30"		200mm	±0.06mm
EC-9006DP	0-1000mm/40"		250mm	±0.08mm

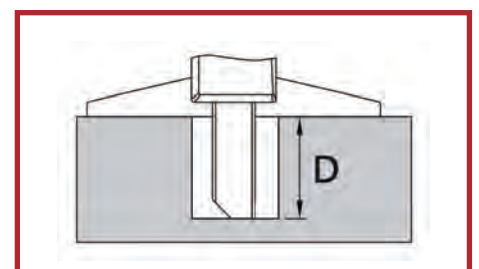

■ Digital Caliper (Outside Groove)

For measuring outside groove diameter, length, wall thickness of slots.

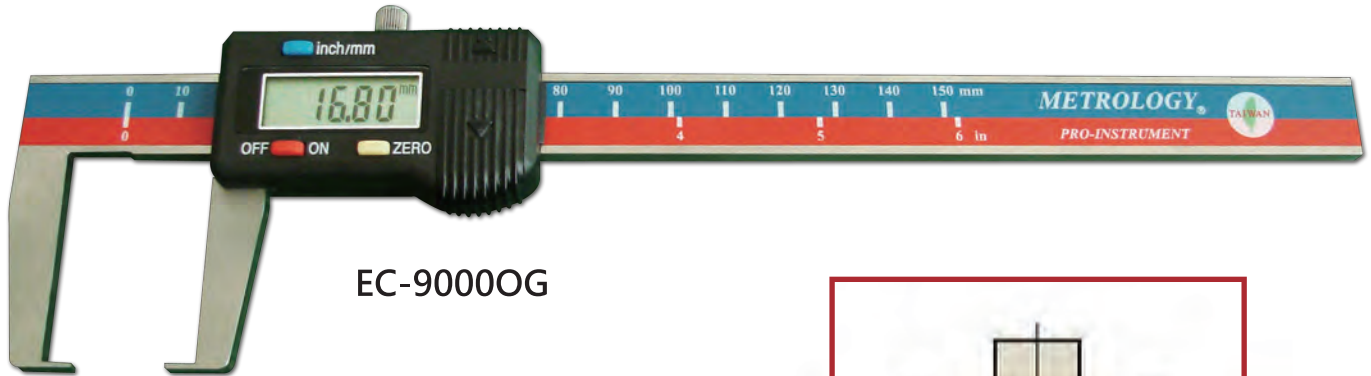

EC-9000OG

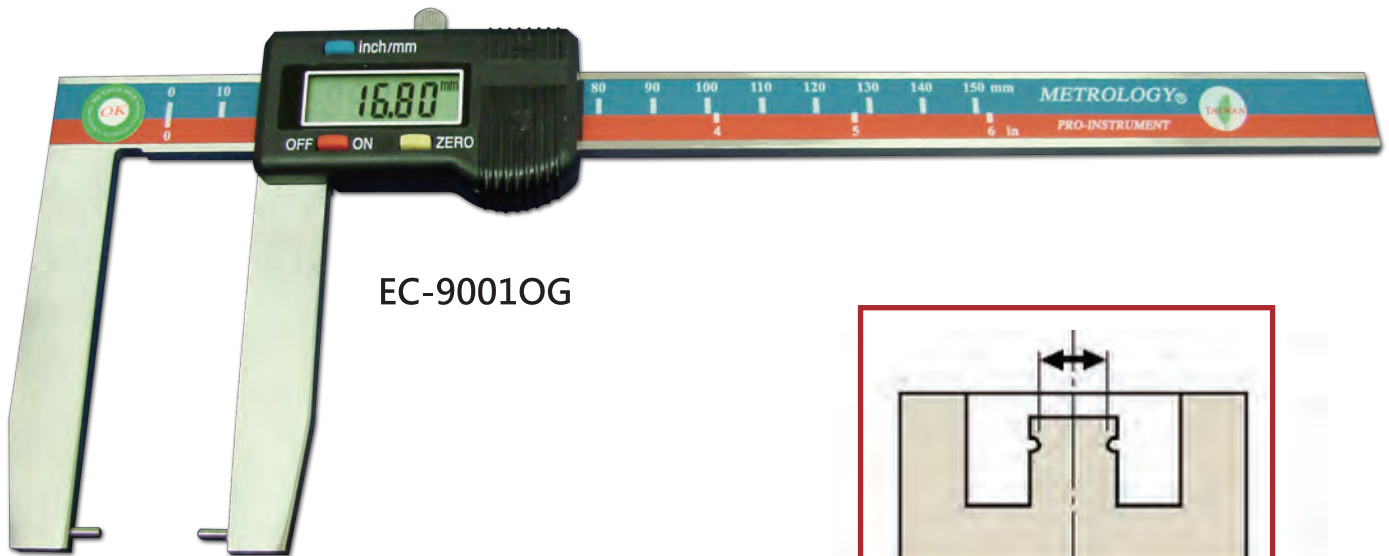
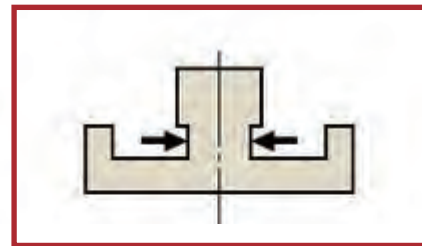

EC-9001OG

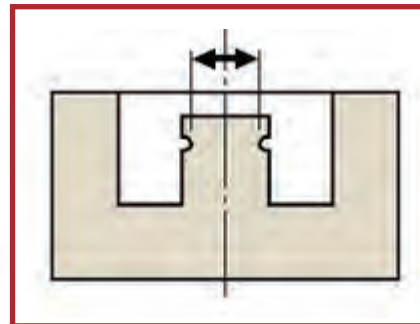

Model No.	Measuring Range	Resolution	Jaw Length	Anvil Dia	Anvil Length	Accuracy
EC-9000OG	0-150mm/6"	0.01mm/0.0005"	40mm	T1mm	5mm	±0.04mm
EC-9001OG	0-150mm/6"		70mm	∅3mm	7mm	±0.05mm
EC-9002OG	0-200mm/8"		110mm	∅3mm	12mm	±0.05mm
EC-9003OG	0-300mm/12"		150mm	∅3mm	12mm	±0.06mm
EC-9004OG	0-500mm/20"		200mm	∅3mm	12mm	±0.07mm

Remark: EC-9000OG come with flat measuring anvils, all other models come with curved anvils.

■ Digital Caliper (Inside Groove)

For measuring inside groove diameter, hole diameter, and distance of workpiece.

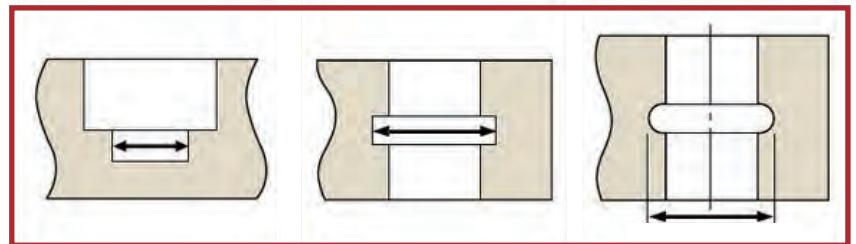
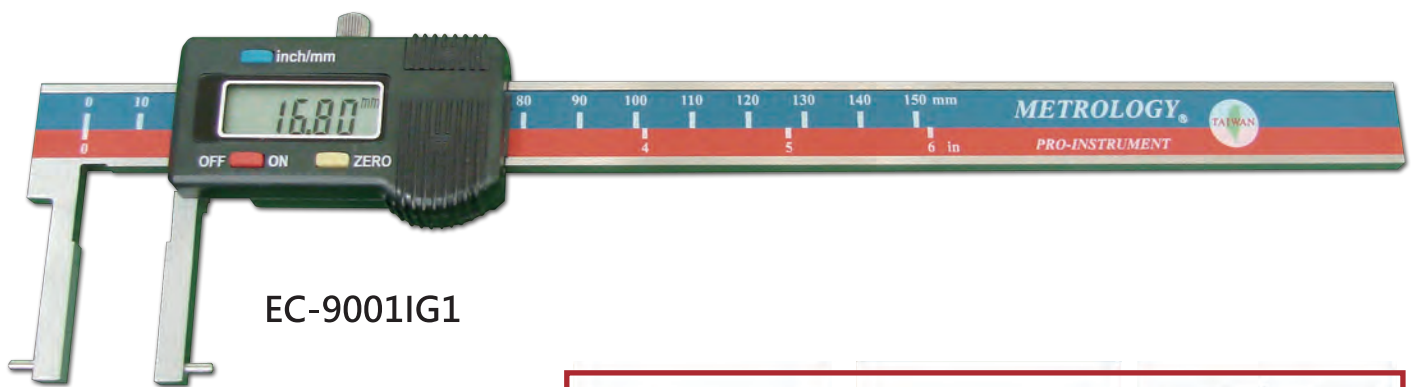
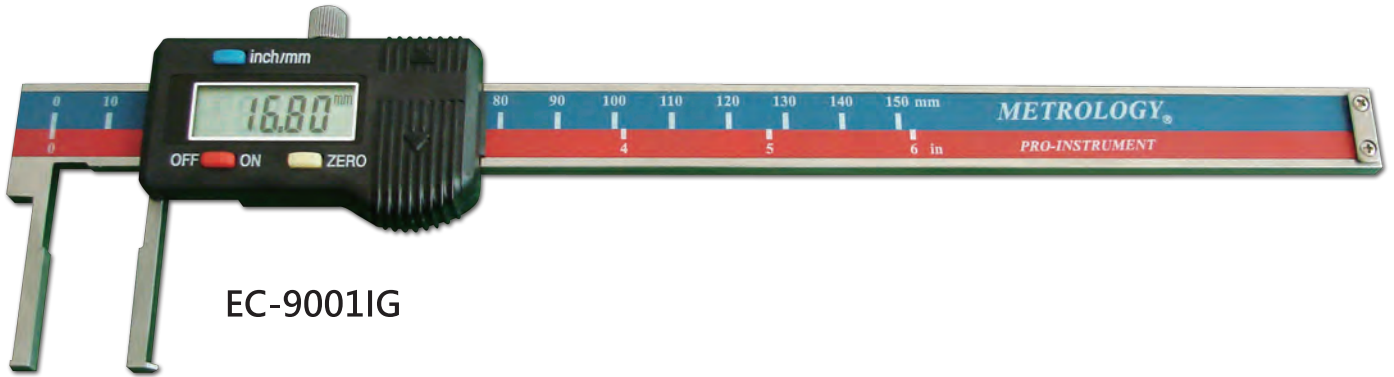

Model No.	Measuring Range	Resolution	Jaw Length	Anvil Dia	Anvil Length	Accuracy
EC-9001IG	10-150mm/6"	0.01mm/0.0005"	30mm	T1mm	2mm	±0.05mm
EC-9001IG1	20-150mm/6"		30mm	ψ2mm	5mm	
EC-9001IG2	35-150mm/6"		60mm	ψ2mm	6mm	
EC-9001IG3	50-150mm/6"		90mm	ψ3mm	8mm	±0.06mm
EC-9002IG1	25-200mm/8"		40mm	ψ2mm	5mm	±0.05mm
EC-9002IG2	40-200mm/8"		70mm	ψ3mm	7mm	
EC-9002IG3	60-200mm/8"		100mm	ψ3mm	10mm	
EC-9003IG1	30-300mm/12"		50mm	ψ2mm	5mm	±0.07mm
EC-9003IG2	50-300mm/12"		80mm	ψ3mm	10mm	
EC-9003IG3	60-300mm/12"		110mm	ψ3mm	10mm	
EC-9004IG1	40-500mm/20"		90mm	ψ3mm	5mm	±0.08mm
EC-9004IG2	60-500mm/20"		120mm	ψ3mm	10mm	
EC-9004IG3	80-500mm/20"		150mm	ψ3mm	16mm	

Remark: EC-9001IG come with flat measuring anvil, all other models come with curved anvils.

■ Digital Caliper (Inside & Outside Interchangeable Anvil)

For measuring outside groove diameter, length, wall thickness of slots, inside groove diameter, hole diameter, and distance of workpiece

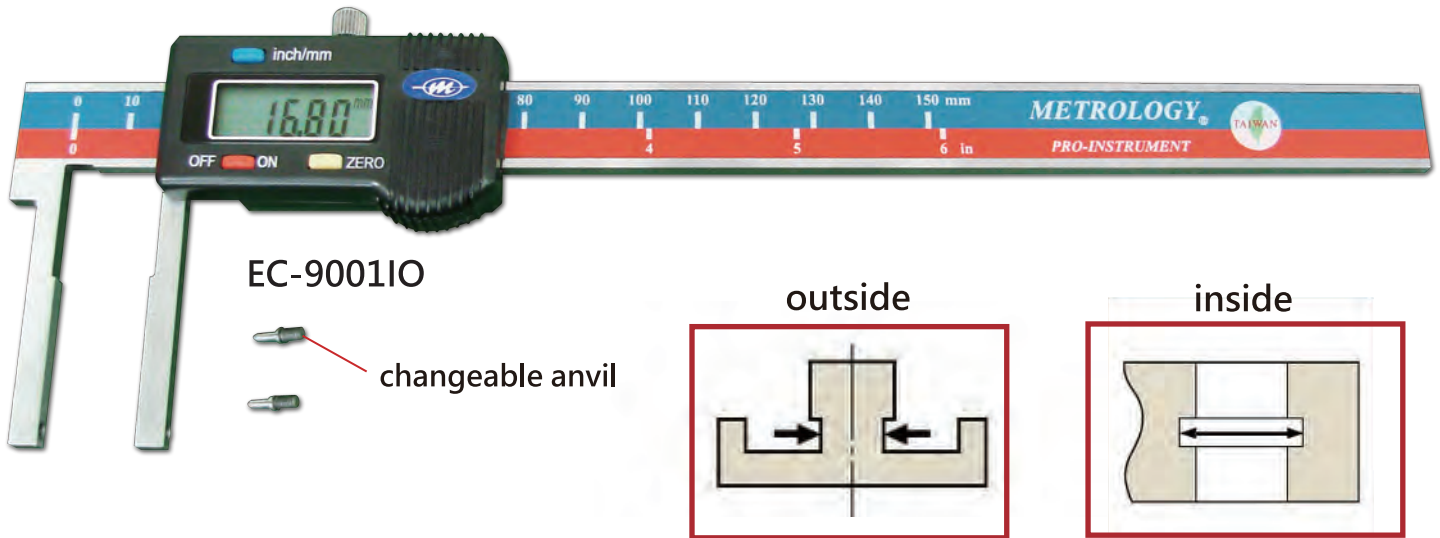

Model No.	Measuring Range	Resolution	Jaw Length	Anvil Dia	Anvil Length	Accuracy
EC-9001IO	0-150mm/6"	0.01mm/0.0005"	40mm	Φ2mm	5mm	±0.05mm
EC-9002IO	0-200mm/8"		50mm			±0.05mm
EC-9003IO	0-300mm/12"		60mm			±0.07mm
EC-9004IO	0-500mm/20"		100mm			±0.08mm

Remark: above measuring range is for external specs. For internal measurements, measuring jaw and anvil dimension must be added.

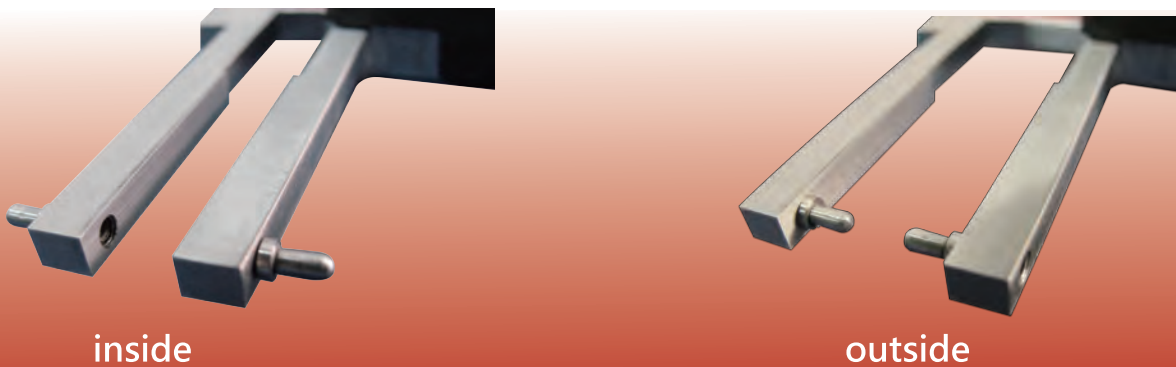

Remark: Measuring tip standard spec is M2.5-6g.

The interchangeable anvils with curved style and custom measuring anvils can be ordered.

■ Digital Caliper (Offset)

The main scale measuring jaw is adjustable.
For measuring outside and inside step distances.

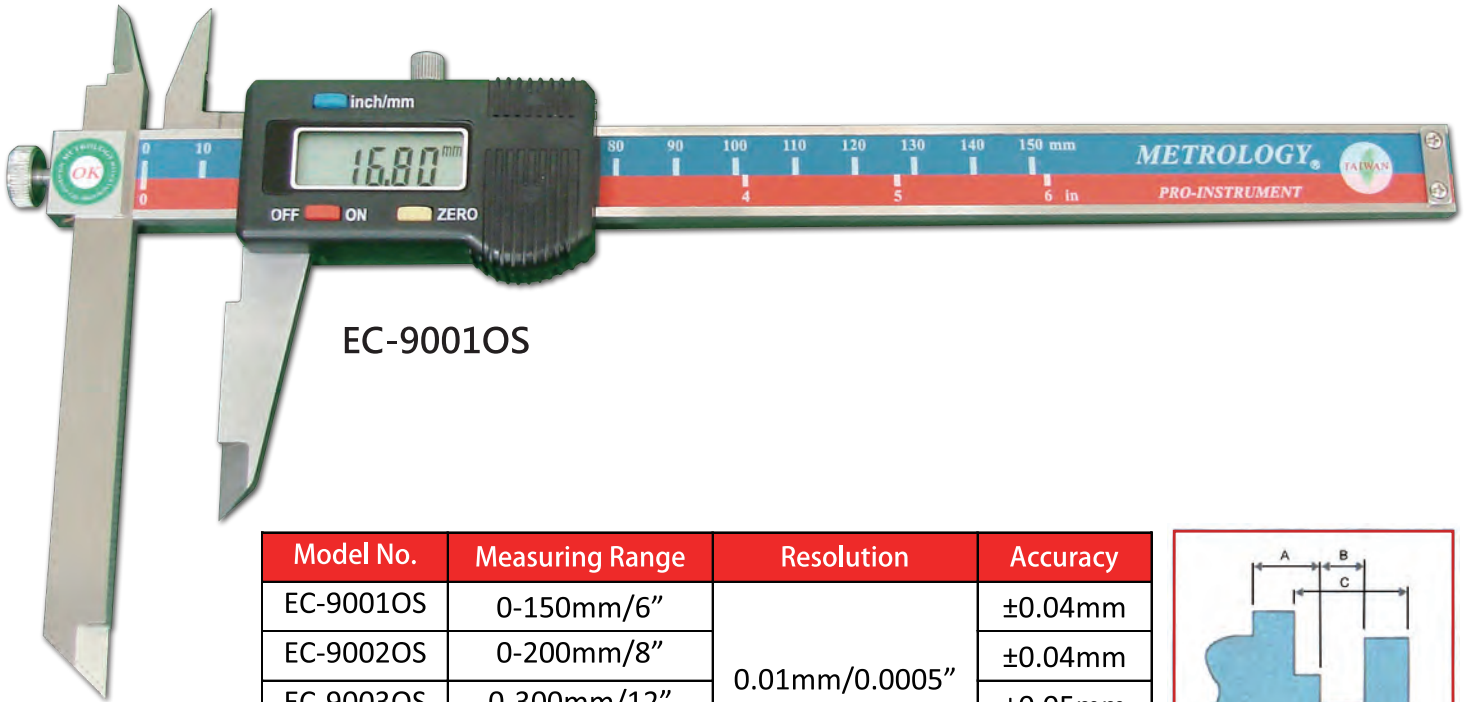

EC-9001OS

Model No.	Measuring Range	Resolution	Accuracy
EC-9001OS	0-150mm/6"	0.01mm/0.0005"	±0.04mm
EC-9002OS	0-200mm/8"		±0.04mm
EC-9003OS	0-300mm/12"		±0.05mm
EC-9004OS	0-500mm/20"		±0.06mm

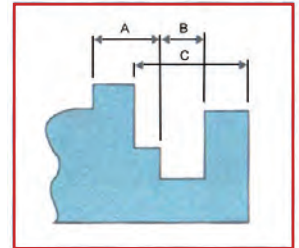

■ Digital Caliper (Tube)

For measuring thickness of the tube wall, and distance of datum point to hole.

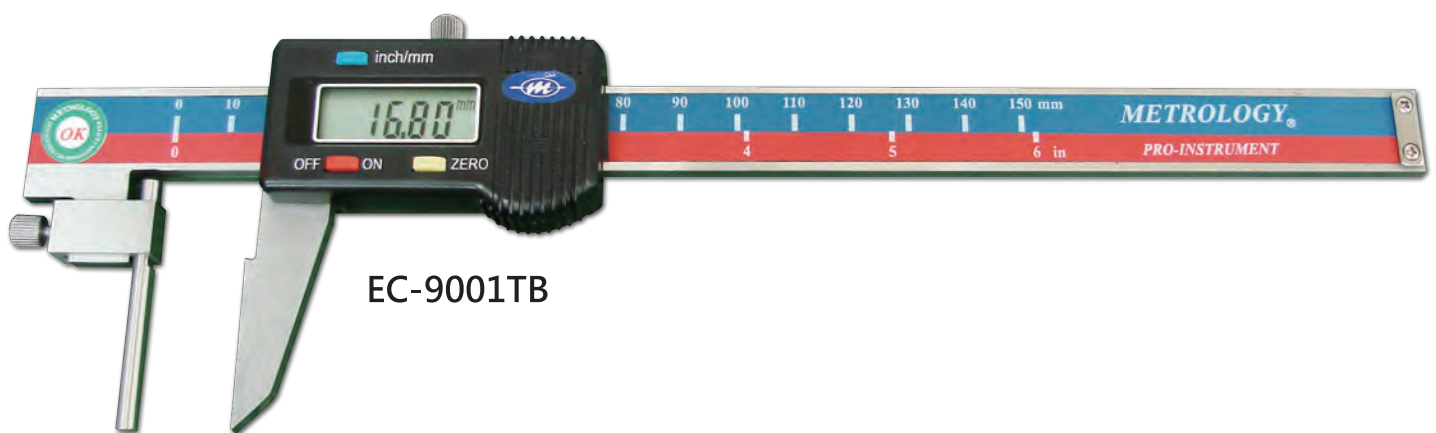

EC-9001TB

Model No.	Measuring Range	Resolution	Accuracy
EC-9001TB	0-150mm/6"	0.01mm/0.0005"	±0.04mm
EC-9002TB	0-200mm/8"		±0.04mm
EC-9003TB	0-300mm/12"		±0.05mm



Remark: Measuring rod standard diameter is 4mm, Custom spec and style can be special ordered.

■ Digital Caliper (Point)

For measuring tight spaces in slots.

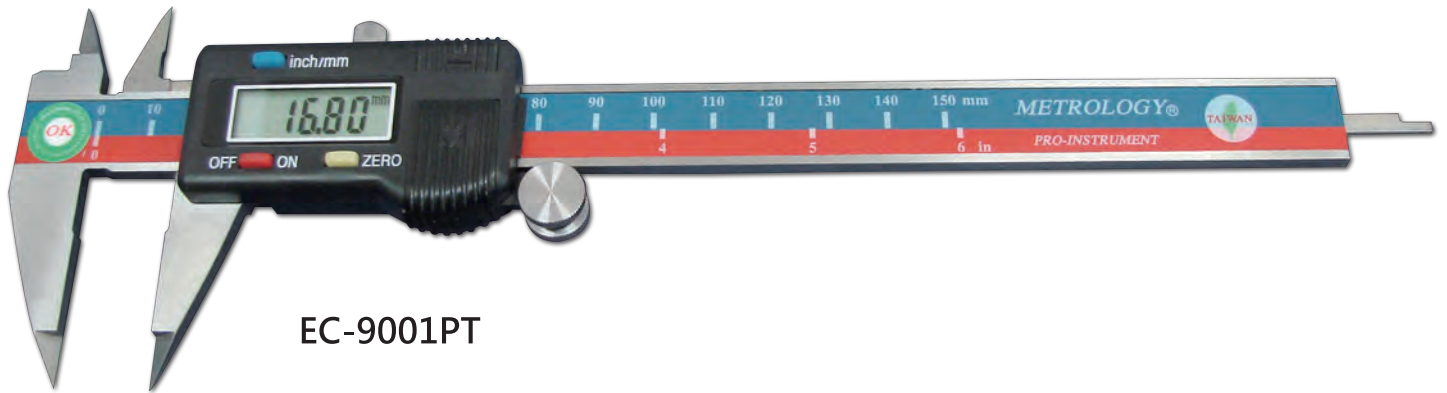

EC-9001PT

Model No.	Measuring Range	Resolution	Accuracy
EC-9001PT	0-150mm/6"	0.01mm/0.0005"	±0.04mm
EC-9002PT	0-200mm/8"		±0.04mm
EC-9003PT	0-300mm/12"		±0.05mm

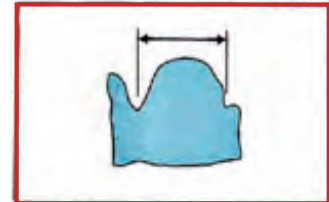

■ Digital Caliper (Blade)

For measuring length or diameter of tight spaces.

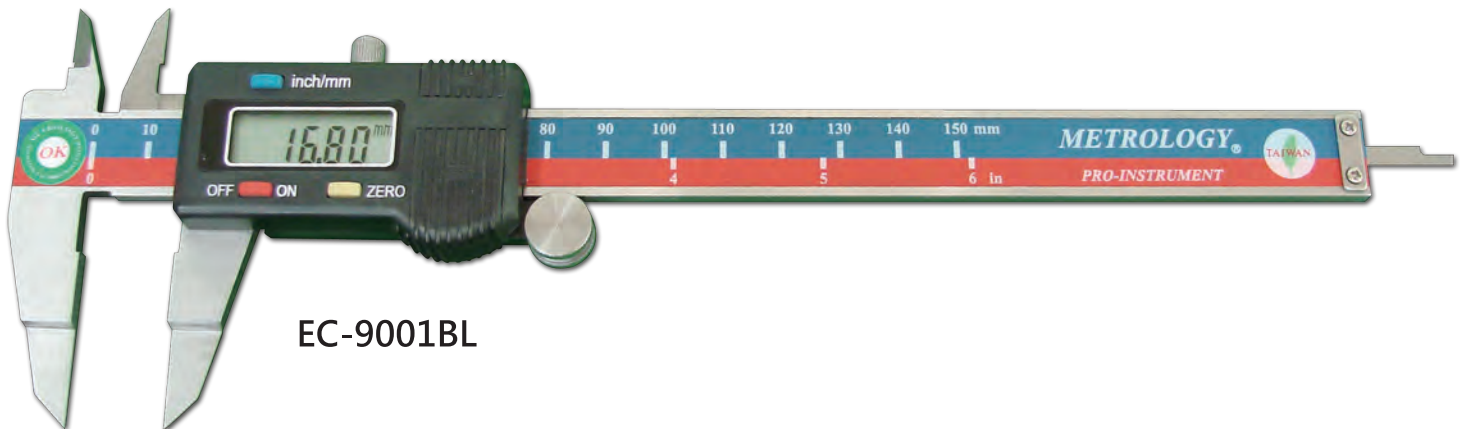

EC-9001BL

Model No.	Measuring Range	Resolution	Accuracy
EC-9001BL	0-150mm/6"	0.01mm/0.0005"	±0.04mm
EC-9002BL	0-200mm/8"		±0.04mm
EC-9003BL	0-300mm/12"		±0.05mm



Remark: the standard measuring jaw thickness is 0.75 mm/ can be special order down to 0.4mm

■ Digital Caliper (Center Distance)

Main scale and the sliding scale measuring jaws are interchangeable.
For measuring center distance between two holes, and hole center to reference face.

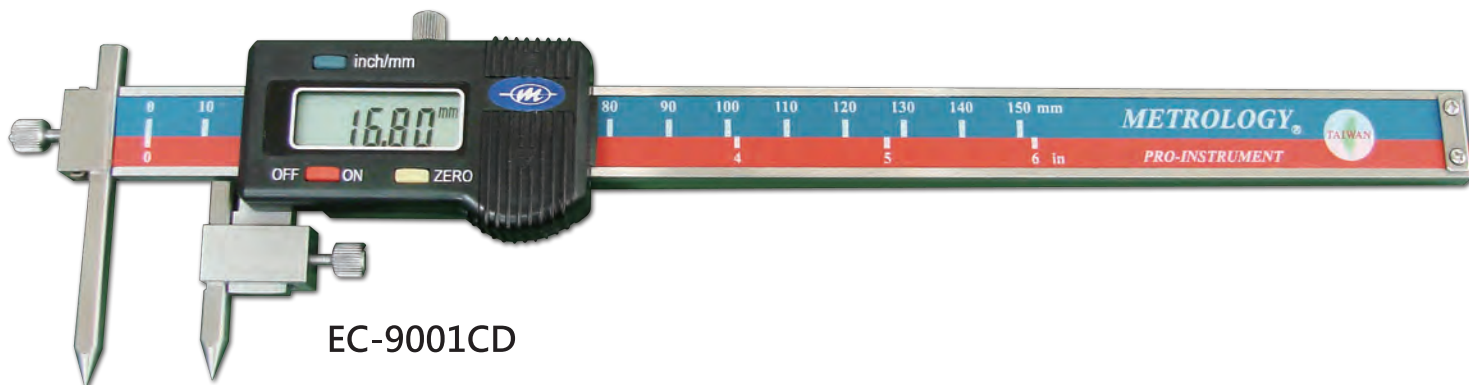

Model No.	Measuring Range	Resolution	Accuracy
EC-9001CD	5-150mm/6"	0.01mm/0.0005"	±0.05mm
EC-9002CD	5-200mm/8"		±0.07mm
EC-9003CD	5-300mm/12"		±0.09mm
EC-9004CD	5-500mm/20"		±0.09mm
EC-9005CD	10-1000mm/40"		±0.13mm

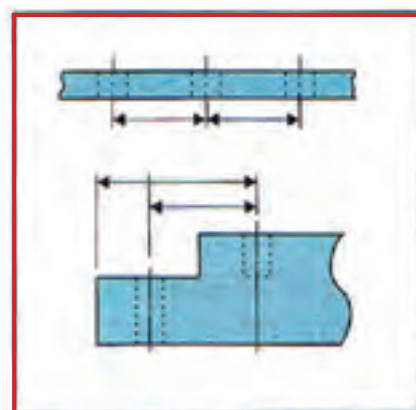

■ Optional Measuring Tip

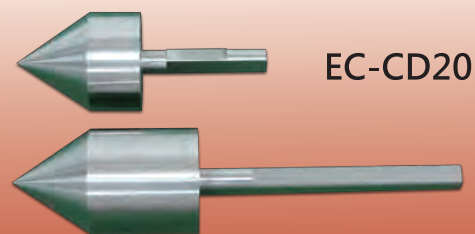
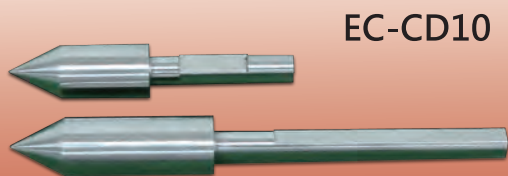

■ Maximum hole diameter : 10 mm (2 piece/pair)

■ Maximum hole diameter : 15mm (2 piece/pair)

■ Maximum hole diameter : 20mm (2 piece/pair)

Remark: Standard measuring rod diameter is 5mm, Custom rod specs and style can be special ordered.

■ Digital Caliper (Screw)

With interchangeable measuring jaws
For measuring head thickness of screws and length of threads.

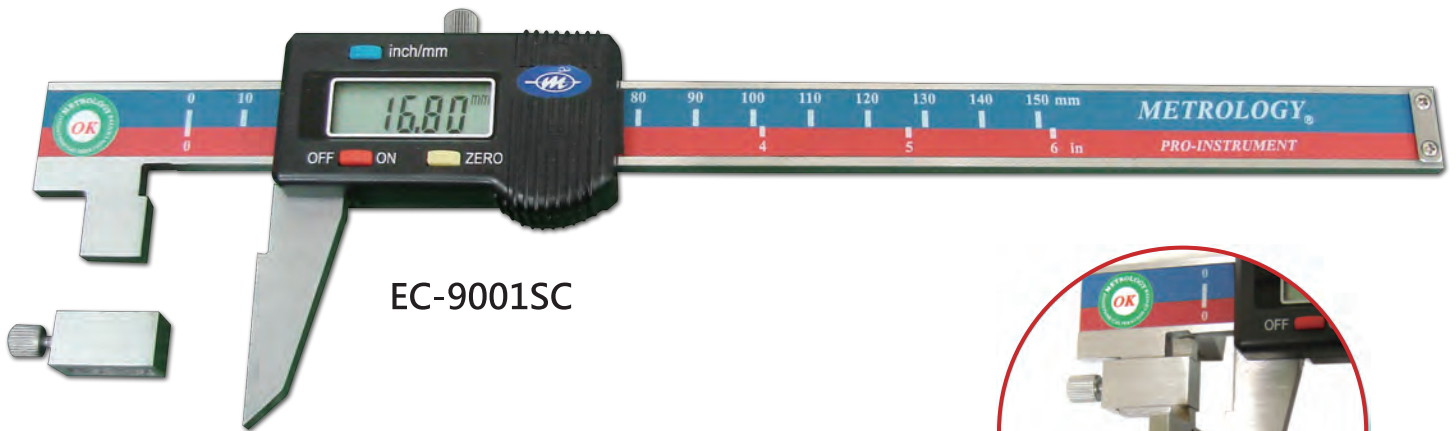

Head thickness



Thread length

Model No.	Measuring Range	Resolution	Accuracy
EC-9001SC	0-150mm/6"	0.01mm/0.0005"	±0.04mm
EC-9002SC	0-200mm/8"		±0.04mm
EC-9003SC	0-300mm/12"		±0.05mm

Remark: Standard accessory exclude measuring jaws

■ Optional measuring jaws

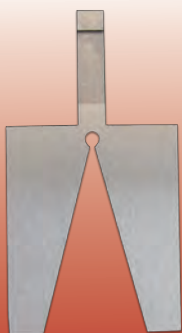

Diameter: for Φ 1-10mm
Size tolerance: \pm 0.003mm
Material: hardened alloy steel
Model Number: EC-SC1

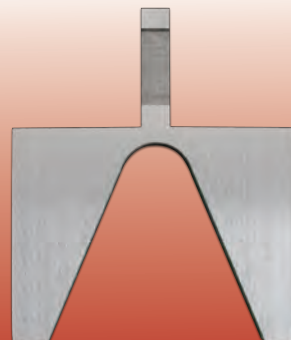

Diameter: for Φ 10-20mm
Size tolerance: \pm 0.003mm
Material: hardened alloy steel
Model Number: EC-SC2

Remark: Standard measuring jaw thickness: 4mm

■ Digital Caliper (Outside Arc Radius)

For measuring external arc radius and diameter of semi-spherical and spherical workpiece.

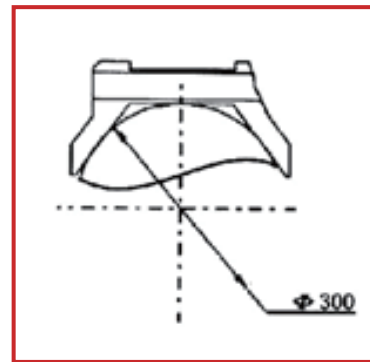

Model No.	Measuring Range	Resolution	Accuracy
EC-9001OR	R3-150mm/6"	0.01mm/0.0005"	±0.06mm
EC-9002OR	R3-200mm/8"		±0.1mm

■ Digital Caliper (Disc)

For measuring thickness of sheets, paper, aluminum, plastic, metal, and gear teeth.

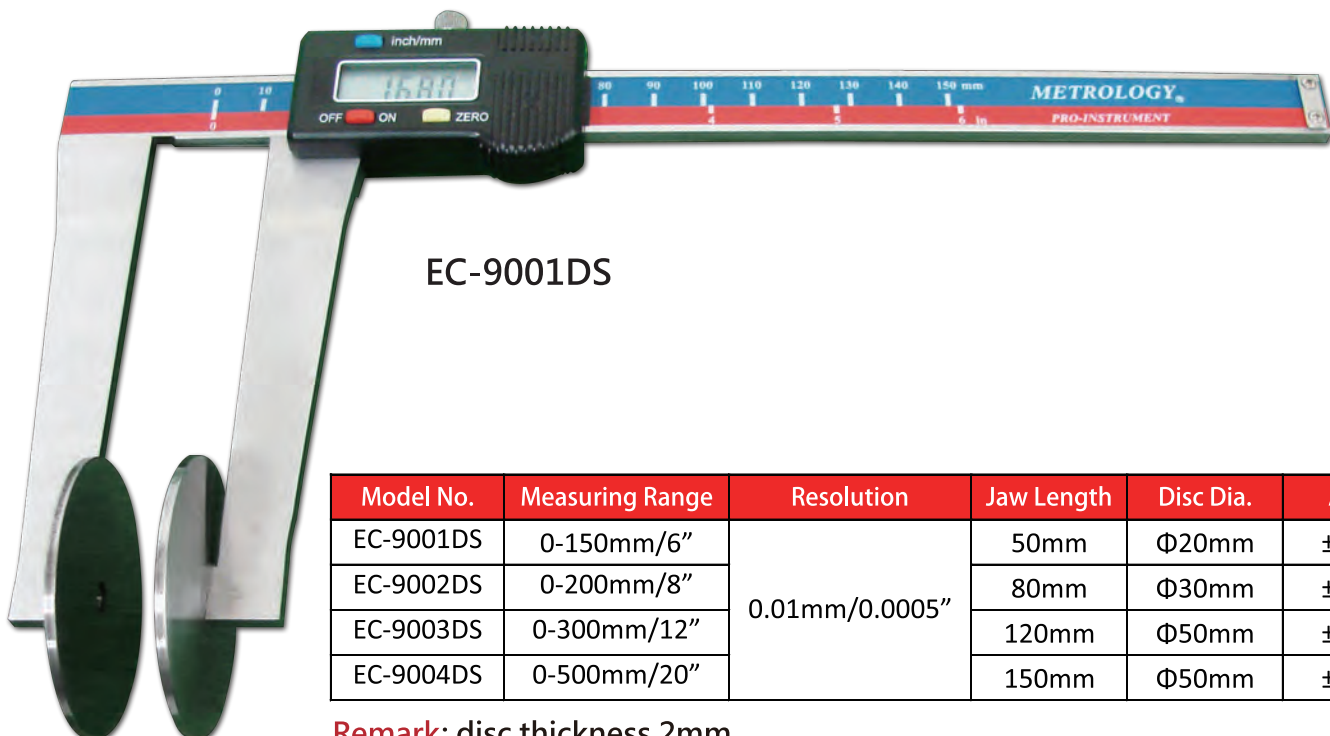

Model No.	Measuring Range	Resolution	Jaw Length	Disc Dia.	Accuracy
EC-9001DS	0-150mm/6"	0.01mm/0.0005"	50mm	Φ20mm	±0.04mm
EC-9002DS	0-200mm/8"		80mm	Φ30mm	±0.05mm
EC-9003DS	0-300mm/12"		120mm	Φ50mm	±0.06mm
EC-9004DS	0-500mm/20"		150mm	Φ50mm	±0.07mm

Remark: disc thickness 2mm

■ Digital Caliper (Groove Width)

For measuring width, distance of internal grooves and distance from groove to reference face.

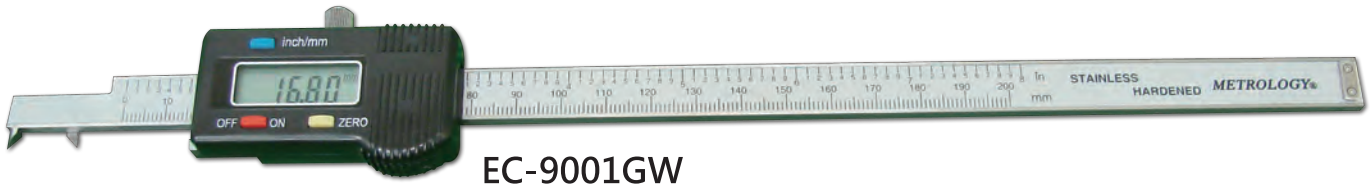

EC-9001GW

Model No.	Measuring Range	Resolution	Accuracy
EC-9001GW	3-150mm/6"	0.01mm/0.0005"	±0.03mm
EC-9002GW	3-200mm/8"		±0.03mm
EC-9003GW	4-300mm/12"		±0.04mm

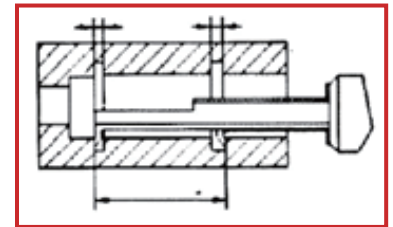

Remark: Main beam width : 17 mm, measuring jaw total width 13xL23mm, jaw width 3mm, and depth 4mm

■ Caliper (Gear Tooth)

For measures gear tooth thickness on the primary diameter.

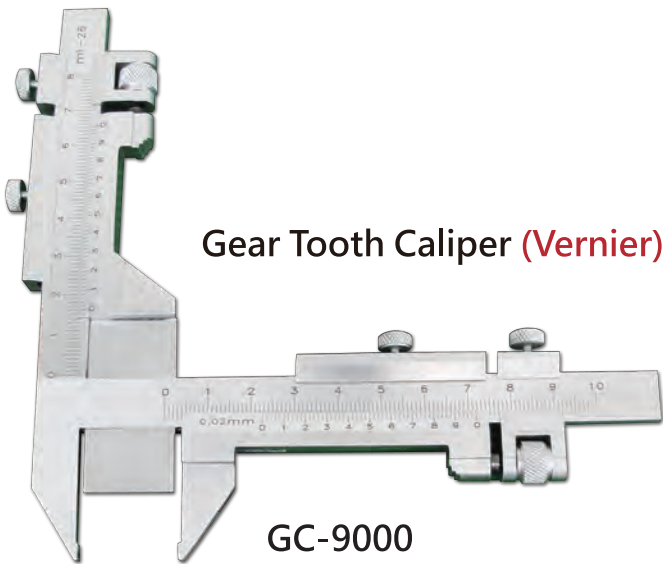

Gear Tooth Caliper (Vernier)

GC-9000

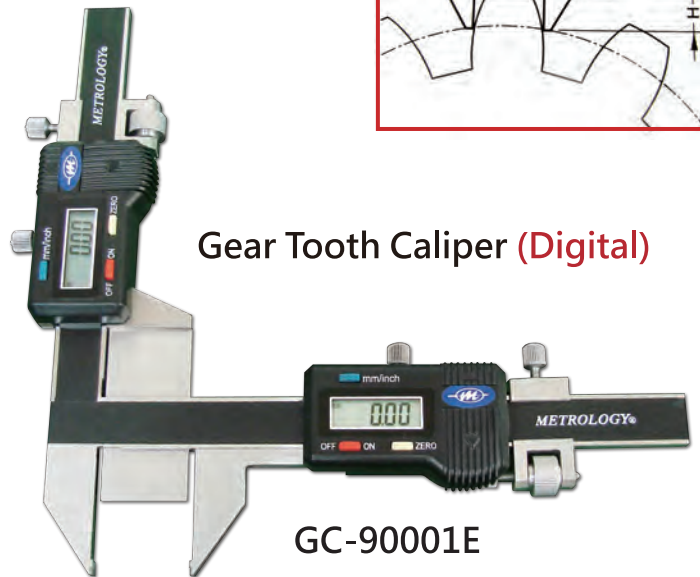

Gear Tooth Caliper (Digital)

GC-90001E

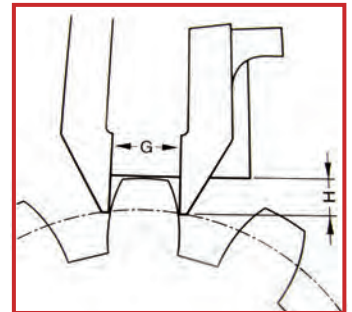

Model No.	Measuring Range	Graduation	Accuracy
GC-9000	M1-26	0.02mm	±0.03mm

Model No.	Measuring Range	Resolution	Accuracy
GC-9001E	M1-25	0.01mm/0.0005"	±0.04mm
GC-9002E	M5-50		

■ Digital Caliper (Mini)



Model No.	Measuring Range	Resolution	Accuracy (MPE)
EC-9100S	0-100mm / 4"	0.01mm/0.0005"	0.03mm/0.0015"

■ Vernier Caliper (Parallel Scribing)

For workpiece dimension scribing and measuring tube thickness.

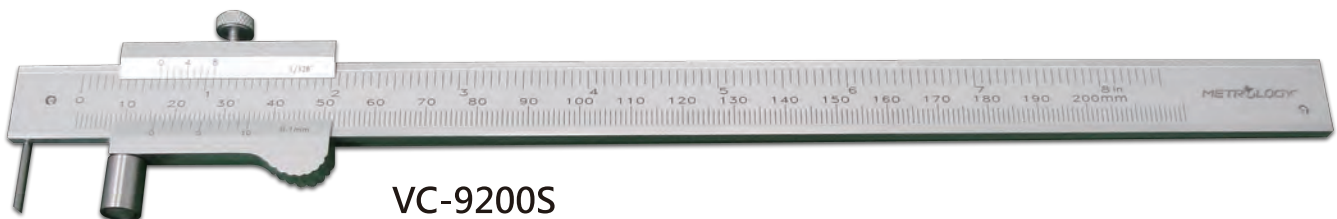

Model No.	Measuring Range	Graduation	Accuracy
VC-9200S	0-200mm/8"	0.1mm/1/128"	±0.1mm

Remark: with Ø 2mm interchangeable tungsten scribing pin

■ Caliper Depth Base

Suitable for calipers within the range of 0 to 300mm. For support of measuring depths.

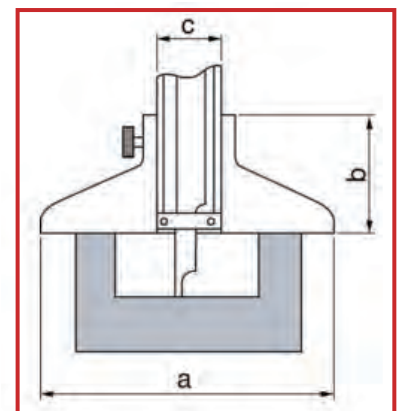
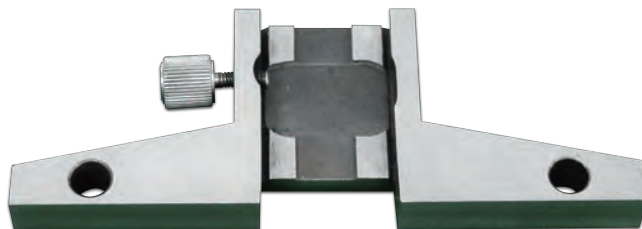

Model No.	Measuring Face	Scale Width	Range
CD-BASE1	80*7.5mm	16mm	For 0-200mm
CD-BASE2	80*7.5mm	17mm	For 0-300mm

Material: Stainless Steel

■ Digital Outside Snap Gauge

For measuring thickness of paper, film, wire, metal sheet, jewel, leather, and etc.



ES-9001



ES-9002

Model No.	Measuring Range	Accuracy
ES-9001	0-12mm / 0.5"	±0.02mm
ES-9002	0-25mm / 1"	±0.03mm

Resolution : 0.01mm / 0.0005"

■ Digital Single Wide Face Gauge

For measuring thickness of paper, film, wire, metal sheet, jewel, leather, cutting tools, machining parts and etc.



Model No.	Measuring Range	Accuracy	Remark
ES-9000SW	0-30mm / 1.2"	±0.03mm	Wide measuring face Width:12mm

Resolution : 0.01mm / 0.0005"

■ Digital 3-way Gauge

For measuring outside, inside diameter and outside groove diameter on small objects.

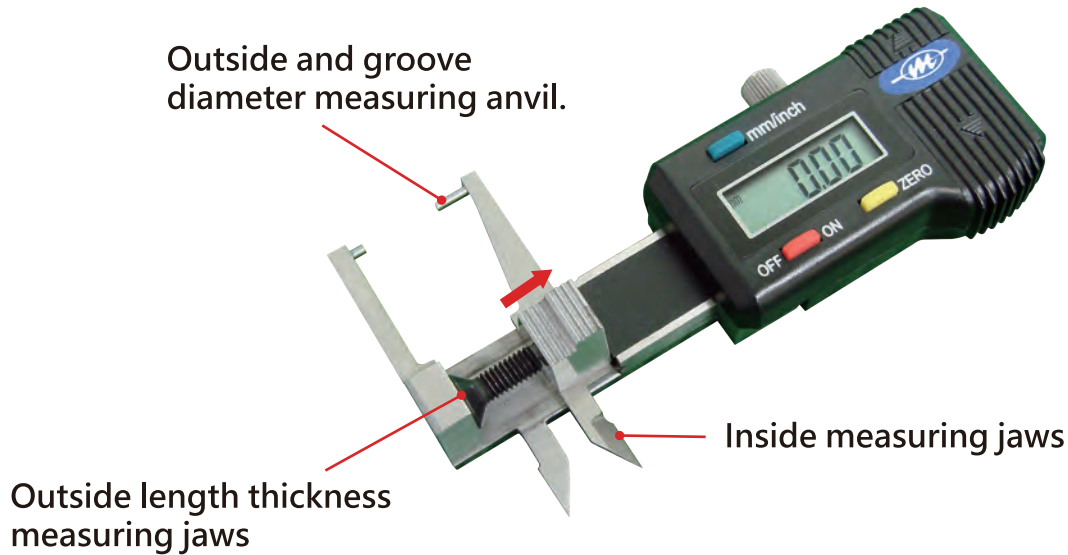

Model No.	Measuring Range	Accuracy
ES-9000TU	0-25mm / 1"	±0.03mm

Resolution : 0.01mm / 0.0005"

■ Digital Welding Gauge

For measuring thickness and height of welding points.



Model No.	Measuring Range	Accuracy
ES-9000WD	0-12.5mm / 0.5"	±0.02mm

Resolution : 0.01mm / 0.0005"

■ Digital Depth Gauge

For measuring depth of tire treads and thickness, depth, steps of varies parts.



Model No.	Measuring Range	Accuracy	Remark
ES-9000DP	0-25mm / 1"	±0.03mm	Plastic base Length: 53mm
ES-9000DS			Steel base Length: 53mm
ES-EB150	L: 150mm		Steel extension base (For DS type)

Resolution: 0.01mm/0.0005"

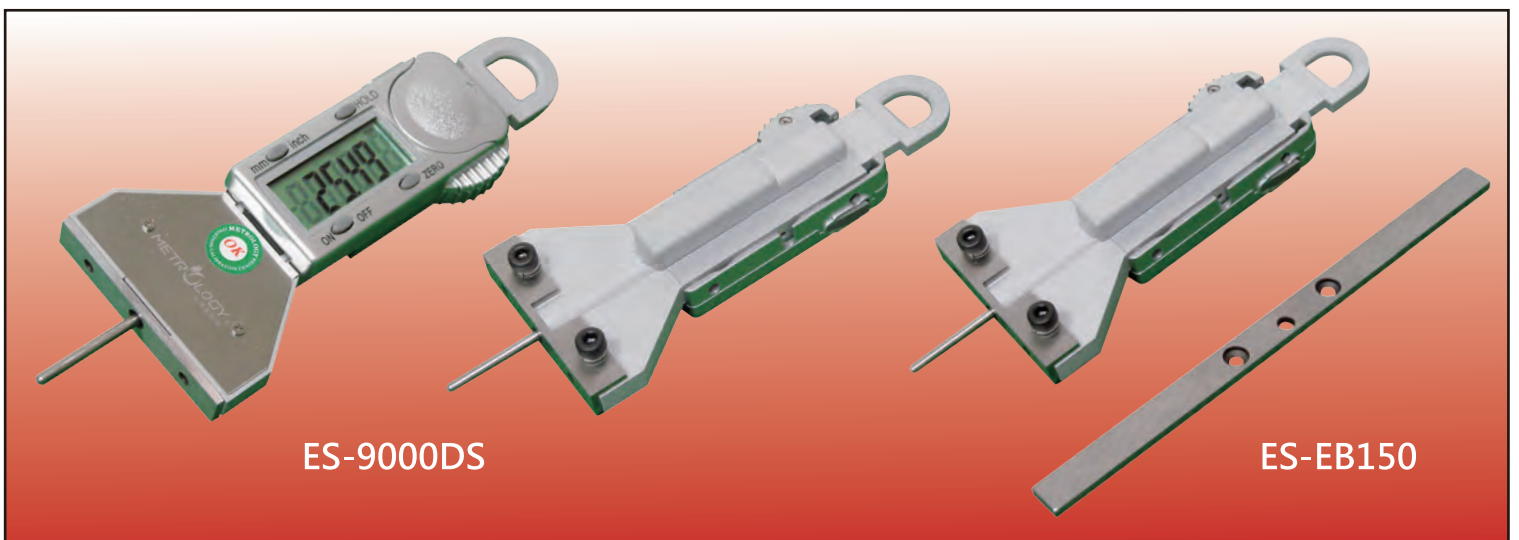

CALIPER

- **METROLOGY**® Large jaw calipers for better structure integrity, sturdiness. Every style come with fine adjustment, for easy to use. Made from stainless steel hardness HRC48-52.
- Our large jaws calipers are for measuring mid-size to large-size items. Measuring external diameter, internal diameter, length and distance. It's simple, fast and reliable. All calipers are calibrated according to ISO and JCC (Jingstone Calibration Center) standards.

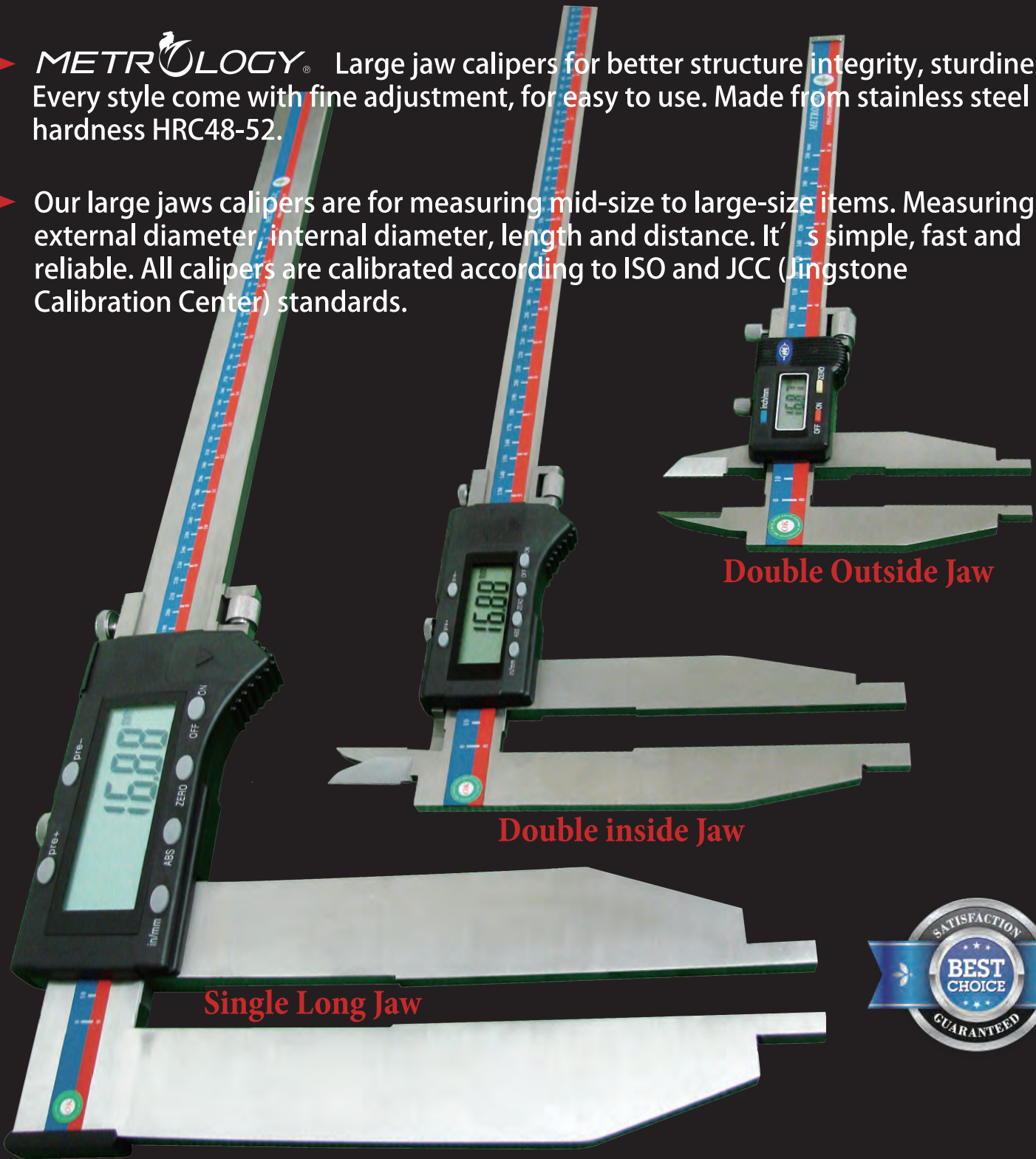

Double Outside Jaw

Double inside Jaw

Single Long Jaw



- Resolution :0.01mm/0.0005"
- MM/INCH: Metric and Imperial system conversion
- OFF/ON: manual switch On and Off
- ZERO: Reset zero at any positions
- ABS: Absolute and increment value conversion
- PRE+/-: Increase or decrease size setting

■ Digital Caliper (Standard Jaw)

For measuring mid-size workpiece external, internal, step, length and distance.

● Blade type inside measuring jaws

● Standard type outside measuring jaws

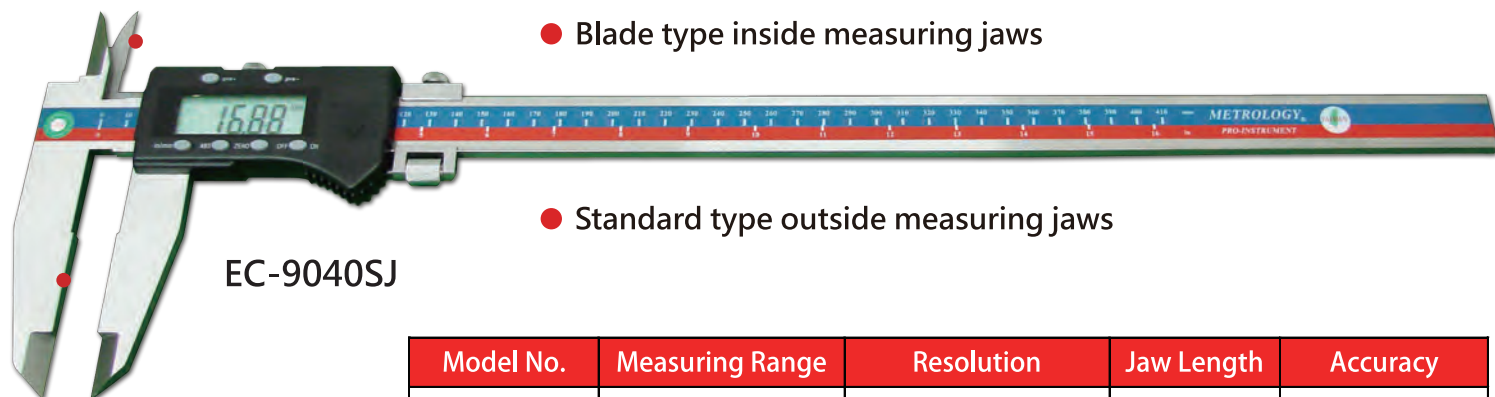

EC-9040SJ

Model No.	Measuring Range	Resolution	Jaw Length	Accuracy
EC-9040SJ	0-400mm/16"	0.01mm/0.0005"	100mm	±0.04mm
EC-9050SJ	0-500mm/20"		100mm	±0.05mm
EC-9060SJ	0-600mm/24"		100mm	±0.05mm
EC-9080SJ	0-800mm/32"		125mm	±0.06mm
EC-9100SJ	0-1000mm/40"		150mm	±0.08mm

■ Digital Caliper (Single Long Jaw)

For measuring small, mid, large size workpiece, external internal, step, length and distance.

● Long type outside measuring jaws

● Radius type inside measuring jaws

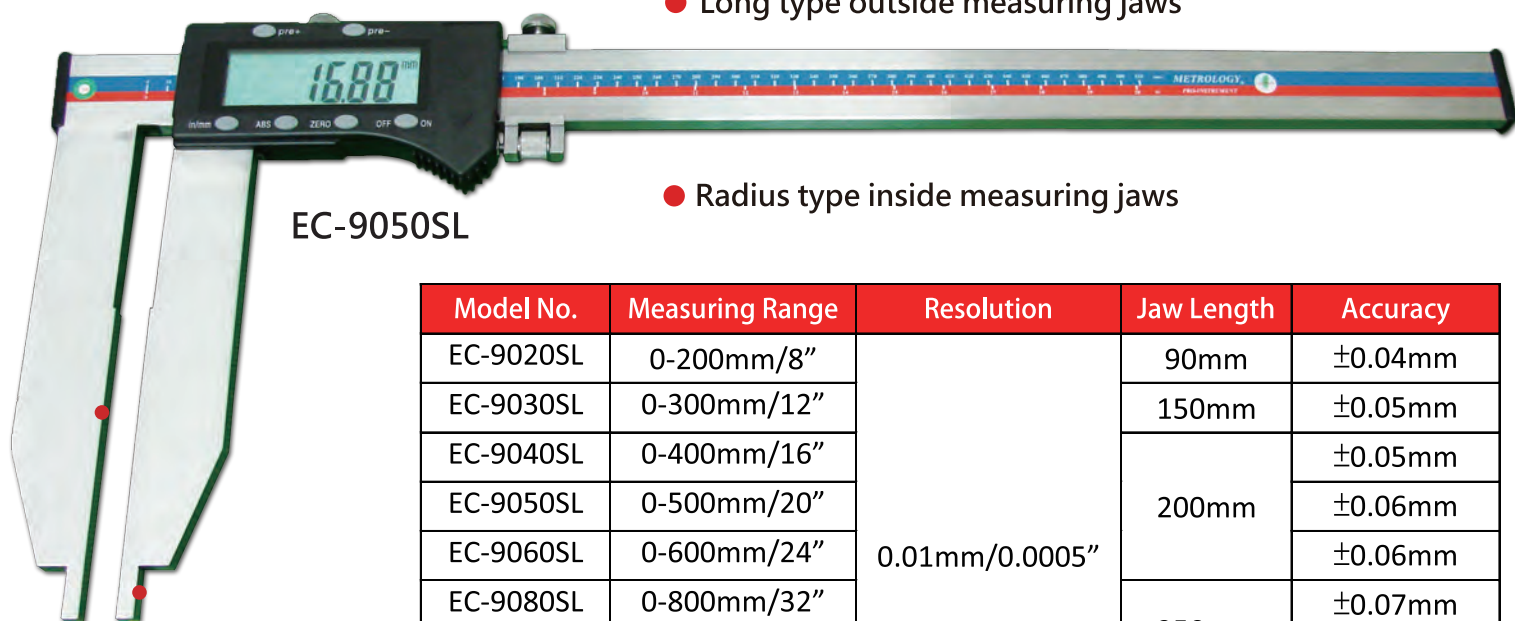

EC-9050SL

Model No.	Measuring Range	Resolution	Jaw Length	Accuracy
EC-9020SL	0-200mm/8"	0.01mm/0.0005"	90mm	±0.04mm
EC-9030SL	0-300mm/12"		150mm	±0.05mm
EC-9040SL	0-400mm/16"		200mm	±0.05mm
EC-9050SL	0-500mm/20"			±0.06mm
EC-9060SL	0-600mm/24"		±0.06mm	
EC-9080SL	0-800mm/32"		250mm	±0.07mm
EC-9100SL	0-1000mm/40"			±0.08mm
EC-9150SL	0-1500mm/60"		300mm	±0.12mm
EC-9200SL	0-2000mm/80"			±0.15mm

■ Digital Caliper (Double Inside Jaw)

For measuring mid-size workpiece external, internal, step, length and distance.

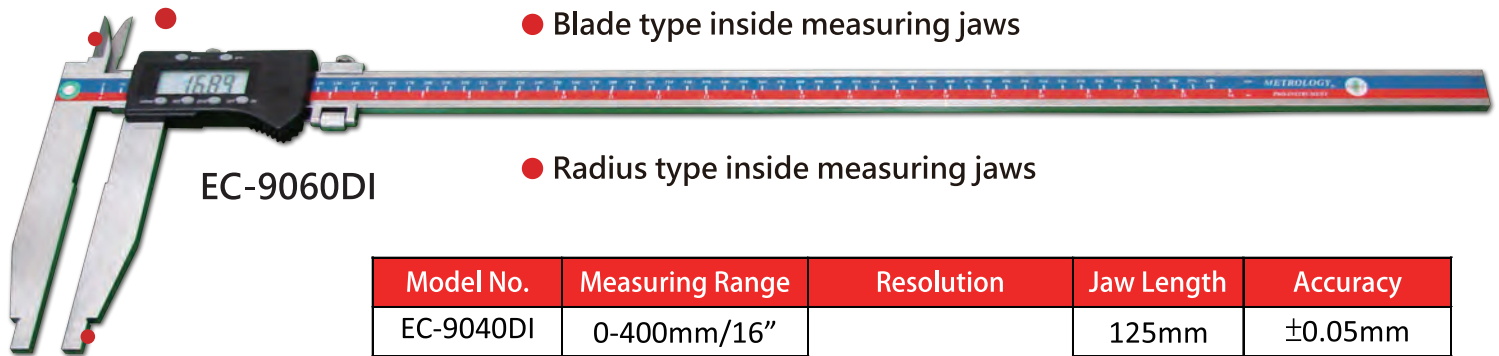

EC-9060DI

● Blade type inside measuring jaws

● Radius type inside measuring jaws

Model No.	Measuring Range	Resolution	Jaw Length	Accuracy
EC-9040DI	0-400mm/16"	0.01mm/0.0005"	125mm	±0.05mm
EC-9050DI	0-500mm/20"		150mm	±0.06mm
EC-9060DI	0-600mm/24"		150mm	±0.06mm
EC-9080DI	0-800mm/32"		150mm	±0.07mm
EC-9100DI	0-1000mm/40"		200mm	±0.08mm

■ Digital Caliper (Double Outside Jaw)

For measuring small, mid, large size workpiece, external internal, step, length and distance.

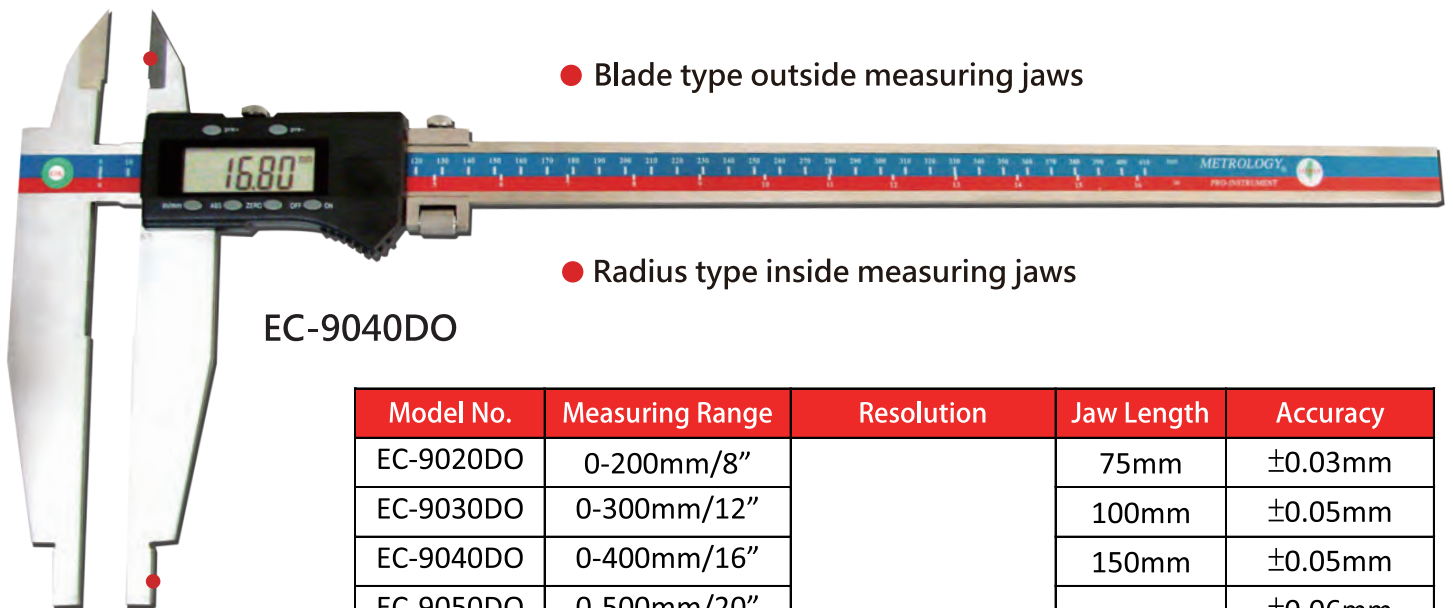

EC-9040DO

● Blade type outside measuring jaws

● Radius type inside measuring jaws

Model No.	Measuring Range	Resolution	Jaw Length	Accuracy
EC-9020DO	0-200mm/8"	0.01mm/0.0005"	75mm	±0.03mm
EC-9030DO	0-300mm/12"		100mm	±0.05mm
EC-9040DO	0-400mm/16"		150mm	±0.05mm
EC-9050DO	0-500mm/20"		200mm	±0.06mm
EC-9060DO	0-600mm/24"			±0.06mm
EC-9080DO	0-800mm/32"			±0.07mm
EC-9100DO	0-1000mm/40"		250mm	±0.08mm
EC-9150DO	0-1500mm/60"			±0.12mm
EC-9200DO	0-2000mm/80"			±0.15mm

■ Digital Scale (Horizontal)

Can be installed on horizontal axis machine table, for measuring moving distance and position.



ES-9040H

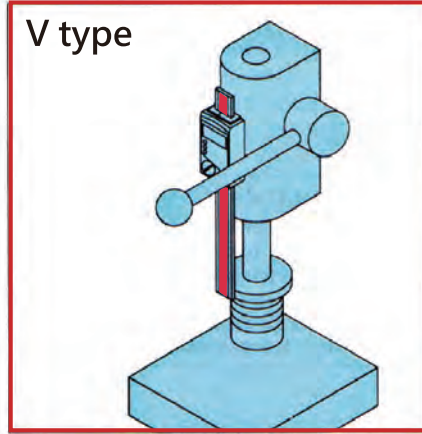
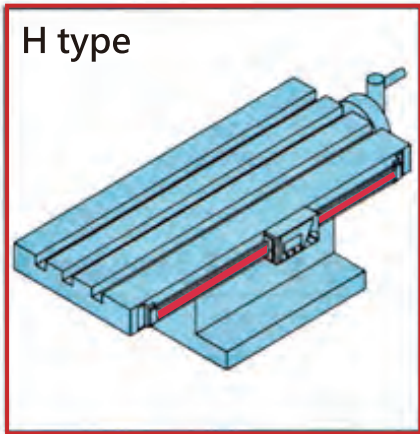

■ Digital Scale (Vertical)

Can be installed on vertical axis machine table, for measuring moving distance and position.

Model No. (Horizontal)	Model No. (Vertical)	Measuring Range (mm)	Accuracy (mm)
ES-9010H	ES-9010V	100	±0.02
ES-9015H	ES-9015V	150	±0.03
ES-9020H	ES-9020V	200	±0.03
ES-9030H	ES-9030V	300	±0.04
ES-9040H	ES-9040V	400	±0.05
ES-9050H	ES-9050V	500	±0.05
ES-9060H	ES-9060V	600	±0.06
ES-9070H	ES-9070V	700	±0.07
ES-9080H	ES-9080V	800	±0.08
ES-9100H	ES-9100V	1000	±0.10
ES-9150H	ES-9150V	1500	±0.15
ES-9200H	ES-9200V	2000	±0.20



ES-9040V

■ Caliper inspection & Calibration equipment



Tower Outside Checker

Checkmaster Gauge

Detail information see page: K8-9

Detail information see page: K2-3

Ring Block



Detail information see page: H23

Cylinder Depth Checker



Detail information see page: K4-5

Multi-Functional Length Calibrator



Detail information see page: K13-24

Gauge Block



Detail information see page: H3-16